



SINCE 1991

**MILA**  
INTERNATIONAL, INC.



*Medical Instrumentation for Animals*

2020 Catalog  
[www.milaint.com](http://www.milaint.com)

MILA International is an innovative company which has developed veterinary medical products otherwise commercially unavailable. We appreciate the opportunity to serve the world's diverse veterinary community since 1991.

<b>Abdominal Drain with</b>			
Blunt Trocar	49		
Accessories & Components	70-71		
Administration Sets	64-66		
Airway Management	52-54		
Anal Sac Catheter	27		
Antimicrobial Catheters	4/7		
Arterial Catheter	12		
Arthroscopy Fluid Line	64		
Aspiration Needle System	21		
Atomizer/Throat Sprayer	53		
Automatic 3-Way	42		
Bacteria Filter	70		
Balloon Dilation Feeding Tube	37		
Balloon Cystostomy and			
Gastrotomy Catheter	26/36		
Barbed Adapters	29/70		
Bellows Suction System	50		
Biopsy Needle	21		
Blake Drains	48		
Bloat Tubes	27		
Blood Collection	65		
Blood Delivery	65		
Blood Filtration	12		
Bone Marrow Aspiration Needle	21		
Brain Biopsy Needle	21		
Broncho Alveolar Lavage - Equine	68		
Bubble Tubing	40		
Caps	20/70		
Castration Drape	51/69		
CathCollar™	35		
Cat Model	36		
<b>CATHETERS</b>			
Arterial	12		
Aspiration	62		
BAL	68		
Centesis	45		
Cystostomy	26/36		
Diffusion/Wound	55		
Economy	28/29		
		<b>CATHETERS Continued</b>	
		Endoscopic	62
		Epidural	55
		Fenestrated	15
		Foley	24-25/67
		Gastrotomy	26/36
		Guttural Pouch	62
		Hemodialysis	13
		PinkPoly™	28-29
		Thoracic	38-40
		Tomcat	22
		Urinary	22-26/28-29/67
		<b>VENOUS ACCESS CATHETERS</b>	
		<b>JUGULAR VEIN</b>	
		Extended Use MILACATH	
		Catheter-Over-Needle	14
		Long Term	
		Central Venous Catheters	
		Seldinger/Guidewire	
		Insertion	4-7
		Peel Away Sheath Insertion	8
		Antimicrobial	7
		PERIPHERAL Introcath Safety	15
		PICC - SILICONE	11
		<b>ADJUSTABLE LONG LINE</b>	
		Drum	10
		Long Line	10
		Veincath	12
		<b>ARTERIAL</b>	12
		<b>INTRAOSSUEOUS/EZIO</b>	11
		<b>REPLACEMENT PIECES</b>	9
		<b>SHORT TERM</b>	14-15
		<b>INSERTION TECHNIQUES</b>	5
		Centesis	40/45
		Centesis Valve	40
		Cerebral Biopsy	21
		Chest Drain Adapters	
		Small Animal	41-43
		Equine	38/69
		Chest Tubes	38-40
		Chest Tube Flush/Lavage Set	69
		Chest Tube Suction Devices	39-43
		Christmas Trees	29/70
		Closed Medication System	
		(Oncology)	56-57
		Connectors	29/70
		Controlled Flushing Set	65
		Conversion Chart	71
		CVP Manometer	11
		Cystostomy Catheter	26/36
		Cytobrush - Protected	63
		Diffusion Catheter	55
		Dispensing Pins	13
		Distributors of MILA Products	78-79
		Drains	48-49
		Drain Adapters	39/41-43
		Drapes	9/51/69
		Echogenic Needles	47/58-59
		Economy Catheters	28-29
		Elastomeric Pump	60
		Embryo Transfer	61
		Endo Pouch	63
		Endoscopic Catheters	62
		Endotracheal Tubes, Exchanger,	
		& Adapters	52-53
		Enteral Feeding Products	28-37
		Epidural Kit	55
		Equine Castration Drape	51/69
		Equine Heimlich Valve	43
		Equine Pharyngeal Swab	69
		Esophageal Balloon Dilation	
		Feeding Tube	37
		Esophagostomy	
		Feeding Tubes	34-36
		Esophagostomy Tunneled	35
		Extended Use MILACATH	14
		Extension Sets	16-19
		Eye Lavage Kit	60
		EZIO - Intraosseous	11
		Fecal Management Kit	44

**FEEDING TUBES (ENTERAL)**

BE Tubes	37
E Tubes	34-36
G Tubes	26/30
J Tubes	31
NG Tubes	28-33
PEG Tubes	30
Feeding Tube Extension	32
Filter - Bacteria	70
Fluid Collection And Delivery	64-66
Fluid Control Dial	66
Fluid Transfer	61/65-66
Flushing for Large Chest Tubes	43/69
Foley Catheters	
Large Animal	25/67
Small Animal	24-25
Gastrotomy	26/30-31/36
GDV / Bloat Tubes	27
Grenade - Suction Bulbs	39/43/48/50
Guidewire Catheters	4-7
Guidewire Introduction	
Chest Tube	38
Guidewires	9
Guttural Pouch	62
Heimlich Valves	43
Hemodialysis Catheters	13
Infusion Pumps	
Clear Cuff Pressure Infusor	67
Elastomeric Pump	60
Injection Ports	9/20
International Distributors	78-79
Intraosseous - EZIO	11
Introcath	15
Introducer Sheath with	
Hemostatic Valve	12
IV Sets	64-66
Jackson Pratt Drains	48
Jejunostomy Tubes	31
Joint Infusion System	68
Lacrimal Lavage Needle	59-60
Lance-A-Lot	62

**Laparoscopic Large Animal**

Retrieval Pouch	63
Long Term Catheters	4-8
Mic-Key: Low Profile	
Gastrotomy Device	31
MicroClave	20
Nasogastric Feeding	
Tubes	28-29/32-33
Needles	27/47/58-59
Nerve Block Products	46-47/59
Olive Tip Needles	
Lacrimal Lavage	59-60
Urinary/Anal Gland	27/59
Oncology	56-57
Oocyte Collection Set	61
Ophthalmic Drape	51
Ordering Information	73
Pain Management	
Diffusion/Wound Catheter	55
Epidural Kit	55
Peripheral Nerve Block	46-47/59
Tuohy Needles	58
Peel Away Introducers	
& Catheters	4-5/8-9
PEG Kit	30
Percutaneous Balloon Catheter	
for Cystostomy	
and Gastrotomy	26/36
Percutaneous Peritoneal	
Drain Kit	44
Pericardial Centesis	45
Peripheral Nerve Block	46-47/59
Peritoneal Dialysis Kit	44
Pharyngeal Swab	69
PICC/Silicone Catheter	11
Pick & Peel Drape	9/51
Pigtail/Nephrostomy Catheter	26
PinkPoly™ Catheters	28/29
Pins	13
Pressure Infusors	67
Pump	60

Reproduction	61
Return Product Information	73
Secondary Venoset	66
Short Term Catheters	14-15
Spinal Needles	47/58
Spiral Drain	49
SPL	60
Stimpod	46
Stimulating Needles	47/58
Stopcocks	19/41/71
Strictures Tube	37
Subpalpebral Eye Lavage	60
Suction Bulbs/Grenades	39/48/50
Suction Connector	41/43
Surgical Drains	48-49
Suture Wings	71
Technical Notes -	
Catheter Insertion Methods	5
Thoracic Catheters	38-40
Throat Sprayers	53
Tomcat Urinary Catheter	22
Tracheal Wash Kit	
Endoscopic	62
Large Animal	68
Small Animal	68
Tracheostomy Tubes	54
Trans-Tracheal Wash Kit	68
Tuohy Needles	58
Tunneler for	
Esophagostomy Tubes	35
Ultrasound Needles	59
URINARY CATHETERS	
Large Animal Foley	25/67
Small Animal Foley	24-25
Tomcat	22
Urine Collection	
Closed System	23
US Distributors	74
Uterine Flush	61
Veincath	12
Weighted Nasogastric Tubes	32-33
Wound Catheter	55

## Long Term Polyurethane Catheter Kits

### INDICATIONS:

The Long Term MILACATH™ is indicated for venous administration of drugs or fluids, blood sampling, TPN and blood pressure monitoring. **Optional silver zirconium phosphate throughout the catheter body**, including the inner and outer surface of the catheter, is designed to inhibit bacteria growth without bacterial resistance. When ordering catheters with silver zirconium phosphate, please look for the 'A' at the end of the item number, indicating 'ANTIMICROBIAL', eg #LA1611-A.

### RECOMMENDED INDWELL TIME:

1-30 days indwelling. The catheter is non-kinking and non-thrombogenic.

### SELECT FROM THESE FEATURES TO DETERMINE ITEM NUMBER NEEDED ON PAGES 6-8:

- 1) Insertion Technique - Guidewire Introduction or Peel Away Introduction.
- 2) Animal Size - Large Animal/Equine or Small Animal/Dogs and Cats.
- 3) Number of Lumens and Length - Single, Double, Triple or Quad Lumens at various lengths.
- 4) Catheter Type - Standard or Antimicrobial.
- 5) Preferred Extensions - Pre-Attached Extension Lines or Non-Attached Extension Lines.

ALL KITS contain: Catheter, scalpel, introducer depending on insertion technique, needle free ports, suture wings, both curved needle with suture and straight needle with suture, drape, and gauze. Those that have extensions include clamps.

### NOTE:

SMALL ANIMAL KITS include a fenestrated drape, 3-0 nylon suture with a straight needle and a curved needle. LARGE ANIMAL KITS include a larger introducer and 2-0 polypropylene suture with a straight needle and a curved needle.

**Single Lumen Catheters** - Available with pre-attached or non-attached extension tube. The 14Ga catheter has a side and distal exit port.

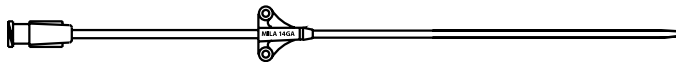

**Multi-Lumen Catheters** - Separate lumens with separate exit points.

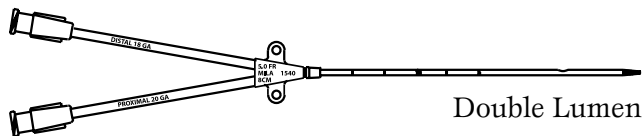

Double Lumen

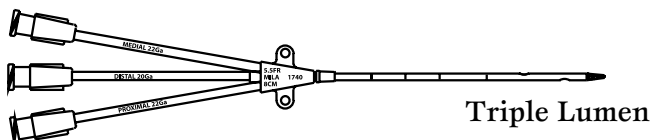

Triple Lumen

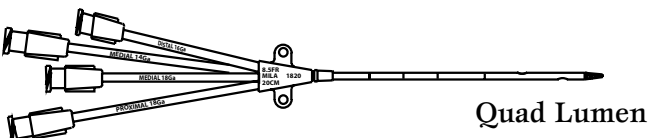

Quad Lumen

Double Lumen

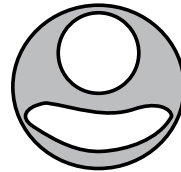

Triple Lumen

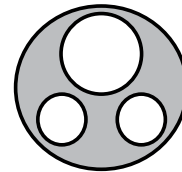

Quad Lumen

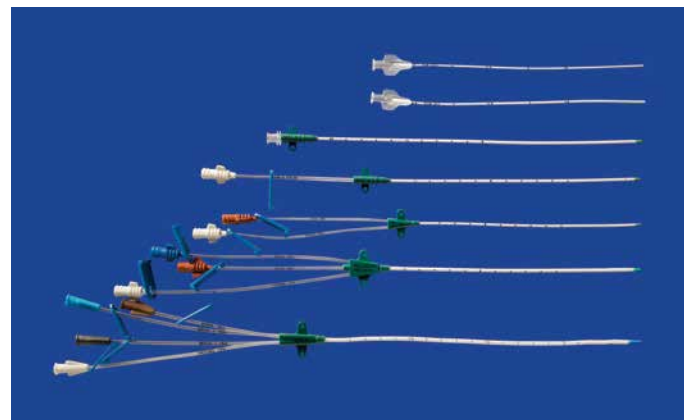
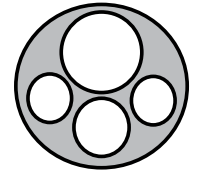

## GUIDEWIRE INTRODUCTION of a Long Term MILACATH®



1 Photo shows introducer being inserted into vein.



2 Guidewire being advanced from housing. Once guidewire advanced to desired length, remove housing and introducer needle while holding onto the guidewire.

**Always hold onto guidewire.**



3 Slide the distal end of the catheter onto guidewire and advance until guidewire comes through the catheter hub.



4 Grasp wire above the catheter hub. Advance catheter into vein by holding catheter near insertion site and pushing into place. Remove guidewire.

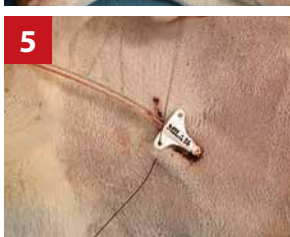

5 Suture catheter individually at each wing around suture groove and toward insertion site. Also, suture the extension to the animal.



**Guidewire Introduction**

## PEEL AWAY INTRODUCTION of a Long Term MILACATH®



1 Hold peel away introducer, bevel up, directly above vein with index finger firmly placed on top of stylet. Advance introducer into vessel far enough to be sure it is well seated.



2 Good flashback should be noted or blood easily drawn into syringe through stylet. Remove stylet while stabilizing outer portion of introducer. Advance long term catheter through catheter of peel away introducer.



3 Hold catheter hub or extension set against animal. Grasp blue tabs with thumb and fore-finger of both hands. Gently pull up and out to separate blue tabs. Introducer should split above the skin.



4 The catheter will back out of insertion site an inch or so during peel away procedure but can be easily pushed back.



5 Suture catheter individually at each wing around suture groove and toward insertion site. Also, suture the extension to the animal.

*Photos courtesy of Hagyard Equine Medical Institute*

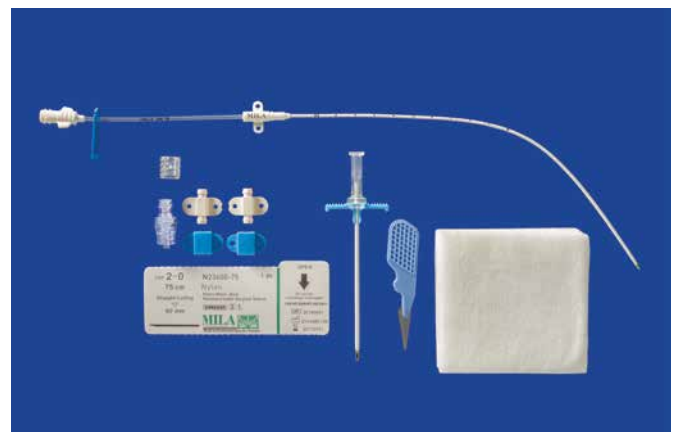

**Peel Away Introduction**

## Long Term MILACATH – Small Animal Kits using GUIDEWIRE INTRODUCTION

All SMALL ANIMAL KITS include radiopaque catheter, fenestrated drape, scalpel, introducer, guidewire, dilator, 3-0 nylon suture with a straight needle and a curved needle, suture wing, needle free injection port, cap, and gauze. Those that have extensions include clamps.

### Single Lumen

DESCRIPTION		ITEM #
24Ga (1.7Fr) x 10cm (4in)	with integrated extension set, 22Ga catheter introducer	SA2410
22Ga (2Fr) x 10cm (4in)	with integrated extension set, 22Ga catheter introducer	SA2210
20Ga (3Fr) x 6.5cm (2.6in)	with integrated extension set, 16Ga catheter introducer	SA2006
20Ga (3Fr) x 12cm (5in)	with integrated extension set, 20Ga catheter introducer	SA2012
19Ga (3.5Fr) x 15cm (6in)	20Ga catheter introducer	SA1915
19Ga (3.5Fr) x 25cm (10in)	20Ga catheter introducer	SA1925
18Ga (4Fr) x 6.5cm (2.6in)	with integrated extension set, 16Ga catheter introducer	SA1806
18Ga (4Fr) x 15cm (6in)	with integrated extension set, 20Ga catheter introducer	SA1815
18Ga (4Fr) x 25cm (10in)	with integrated extension set, 20Ga catheter introducer	SA1825
16Ga (5Fr) x 9cm (3.5in)	with integrated extension set, 18Ga catheter introducer	SA1609
16Ga (5Fr) x 15cm (6in)	with integrated extension set, 18Ga catheter introducer	SA1615
16Ga (5Fr) x 20cm (8in)	with integrated extension set, 18Ga catheter introducer	SA1620
16Ga (5Fr) x 30cm (12in)	with integrated extension set, 18Ga catheter introducer	SA1630
14Ga (6Fr) x 6.5cm (2.6in)	with integrated extension set, 16Ga catheter introducer	SA1406
14Ga (6Fr) x 15cm (6in)	with integrated extension set, 16Ga catheter introducer	SA1415
14Ga (6Fr) x 20cm (8in)	with integrated extension set, 16Ga catheter introducer	SA1420

### Double Lumen

4Fr x 8cm (3.25in)	with two 22Ga lumens, 20Ga catheter introducer	SA4FD08
4Fr x 13cm (5.25in)	with two 22Ga lumens, 20Ga catheter introducer	SA4FD13
4Fr x 30cm (12in)	with two 22Ga lumens, 20Ga catheter introducer	SA4FD30
5Fr x 8cm (3.25in)	with a 18Ga & 20Ga lumen, 20Ga catheter introducer	SA5FD08
5Fr x 13cm (5.25in)	with a 18Ga & 20Ga lumen, 20Ga catheter introducer	SA5FD13
5Fr x 25cm (10in)	with a 18Ga & 20Ga lumen, 20Ga catheter introducer	SA5FD25
7Fr x 15cm (6in)	with a 14Ga & 18Ga lumen, 18Ga catheter introducer	SA7FD15
7Fr x 20cm (8in)	with a 14Ga & 18Ga lumen, 18Ga catheter introducer	SA7FD20
7Fr x 30cm (12in)	with a 14Ga & 18Ga lumen, 18Ga catheter introducer	SA7FD30
7Fr x 60cm (24in)	with two 16Ga lumens, 18Ga catheter introducer	SA7FD60

### Triple Lumen

5.5Fr x 8cm (3.25in)	with one 20Ga & two 22Ga lumens, 20Ga catheter introducer	SA5FT08
5.5Fr x 13cm (5.25in)	with one 20Ga & two 22Ga lumens, 20Ga catheter introducer	SA5FT13
5.5Fr x 30cm (12in)	with one 20Ga & two 22Ga lumens, 20Ga catheter introducer	SA5FT30
7Fr x 15cm (6in)	with one 16Ga & two 18Ga lumens, 18Ga catheter introducer	SA7FT15
7Fr x 20cm (8in)	with one 16Ga & two 18Ga lumens, 18Ga catheter introducer	SA7FT20
7Fr x 30cm (12in)	with one 16Ga & two 18Ga lumens, 18Ga catheter introducer	SA7FT30
7Fr x 60cm (24in)	with one 16Ga & two 18Ga lumens, 18Ga catheter introducer	SA7FT60

### Quadruple Lumen

8.5Fr x 20cm (8in)	with one 16Ga, one 14Ga and two 18Ga lumens, 18Ga introducer	SA8FQ20
--------------------	--	---------



## Long Term MILACATH – Large Animal Kits using GUIDEWIRE INTRODUCTION

All LARGE ANIMAL KITS include radiopaque catheter, scalpel, introducers, guidewire, dilator, 2-0 polypropylene *pink* suture with a straight needle and a curved needle, suture wing, needle free port, cap, and gauze. Those that have extensions include clamps.

### Single Lumen

DESCRIPTION	ITEM #
16Ga (5Fr) x 11cm (4.5in) antimicrobial catheter, choice of 18Ga/16Ga introducers	LA1611-A**
16Ga (5Fr) x 15cm (6in) with integrated extension set, choice of 18Ga/16Ga introducers	LA1615**
16Ga (5Fr) x 15cm (6in) antimicrobial catheter, choice of 18Ga/16Ga introducers	LA1615-A**
16Ga (5Fr) x 15cm (6in) extension set, choice of 18Ga/16Ga introducers	LA1615-2P**
<b>**ABOVE PRODUCTS RECOMMENDED FOR FOALS.</b>	
16Ga (5Fr) x 20cm (8in) with integrated extension set, 16Ga introducers	LA1620
16Ga (5Fr) x 20cm (8in) antimicrobial catheter, 16Ga introducers	LA1620-A
16Ga (5Fr) x 20cm (8in) extension set, 16Ga introducers	LA1620-2P
14Ga (6Fr) x 15cm (6in) with integrated extension set, choice of 14Ga introducers	LA1415
14Ga (6Fr) x 15cm (6in) extension set, choice of 14Ga introducers	LA1415-2P
14Ga (6Fr) x 20cm (8in) with integrated extension set, choice of 14Ga introducers	LA1420
14Ga (6Fr) x 20cm (8in) antimicrobial catheter, choice of 14Ga introducers	LA1420-A
14Ga (6Fr) x 20cm (8in) extension set, choice of 14Ga introducers	LA1420-2P
12Ga (8Fr) x 20cm (8in) with integrated extension set, choice of 14Ga introducers	LA1220

### NEW - BOVINE KIT

12Ga (8Fr) x 20cm (8in) with integrated extension set, 14Ga needle introducer	B1220
---	-------

### Double Lumen

7Fr x 15cm (6in) with 14Ga & 18Ga lumen, choice of 16Ga/14Ga introducers	LA7FD15**
<b>**ABOVE PRODUCT RECOMMENDED FOR FOALS.</b>	
7Fr x 20cm (8in) with 14Ga & 18Ga lumen, choice of 16Ga/14Ga introducers	LA7FD20

### Triple Lumen

7Fr x 15cm (6in) with one 16Ga & two 18Ga lumens, 16Ga introducer	LA7FT15
---	---------

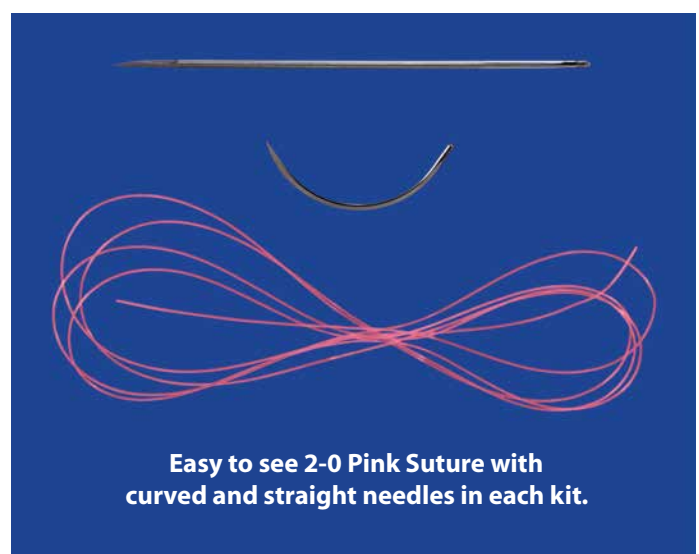

## Long Term MILACATH - Small and Large Animal Kits using PEEL AWAY INTRODUCTION

All SMALL ANIMAL KITS include radiopaque catheter, drape, scalpel, peel away introducer, 3-0 nylon suture with a straight needle and a curved needle, suture wing, needle free port, cap, and gauze. Those that have extensions include clamps.

### Small Animal Single Lumen

DESCRIPTION	ITEM #
19Ga (3.5Fr) x 15cm (6in) 4Fr x 1.5 inch peel away introducer	SA1915-PI
19Ga (3.5Fr) x 25cm (10in) 4Fr x 1.5 inch peel away introducer	SA1925-PI
16Ga (5Fr) x 15cm (6in) extension set, 5Fr x 2.5 inch peel away introducer	SA1615-2P-PI
16Ga (5Fr) x 25cm (10in) extension set, 5Fr x 2.5 inch peel away introducer	SA1625-2P-PI

### Small Animal Double Lumen

4Fr x 8cm (3.25in)	with two 22Ga lumens, 4Fr x 1.5 inch peel away introducer	SA4FD08-PI
4Fr x 13cm (5.25in)	with two 22Ga lumens, 4Fr x 1.5 inch peel away introducer	SA4FD13-PI
5Fr x 8cm (3.25in)	with a 18Ga & 20Ga lumen, 5Fr x 1.5 inch peel away introducer	SA5FD08-PI
5Fr x 13cm (5.25in)	with a 18Ga & 20Ga lumen, 5Fr x 1.5 inch peel away introducer	SA5FD13-PI
5Fr x 25cm (10in)	with a 18Ga & 20Ga lumen, 5Fr x 2.5 inch peel away introducer	SA5FD25-PI

**All LARGE ANIMAL KITS** include radiopaque catheter, scalpel, peel away introducer, 2-0 polypropylene *pink* suture with a straight needle and a curved needle, suture wing, needle free port, cap, and gauze. Those that have extensions include clamps.

### Large Animal Single Lumen

DESCRIPTION	ITEM #
16Ga (5Fr) x 15cm (6in) with integrated extension set, 5Fr x 1.5 inch peel away introducer	LA1615-PI
16Ga (5Fr) x 20cm (8in) with integrated extension set, 5Fr x 2.5 inch peel away introducer	LA1620-PI
14Ga (6Fr) x 20cm (8in) with integrated extension set, 6Fr x 1.5 inch peel away introducer	LA1420-PI



Peel Away Introduction Kit - Small Animal



Peel Away Introducer



Peel Away Introduction Kit - Large Animal



## Pick & Peel Surgical Drape

Use for maintaining a sterile field for catheter placement. Each drape allows the user to select a 3.75cm (1.5in) or 6.9cm (2.75in) fenestration. Drape size 60cm x 60cm (24in x 24in).

- Adhesive apertures.
- Sterile, impervious, translucent film.
- Provides superb translucent protection from fluids with optimal drapeability.
- Helps keep patient warm.
- Can be used for small animal DENTAL procedures. Put animal snout through the aperture.

ITEM #PPD



Additional drapes on page 51

## Peel Away Introducers

Facilitate the placement of catheters and tubing with these high quality introducers. They peel apart cleanly after introduction. Used in MILA long term catheter kits and PICC kits.

DESCRIPTION	ITEM #
3Fr (20Ga) x 3.75cm (1.5in)	4203
4Fr (18Ga) x 3.75cm (1.5in)	4204
5Fr (16Ga) x 3.75cm (1.5in)	4205.5
5Fr (16Ga) x 6.25cm (2.5in)	4205
6Fr (14Ga) x 3.75cm (1.5in)	4206.5
6Fr (14Ga) x 6.25cm (2.5in)	4206



## Guidewires

DESCRIPTION	ITEM #
0.018in x 45cm guidewire with one soft flexible 'J' end and one soft flexible straight end	GW1845
0.018in x 50cm Hydrophilic coated nitinol wire with steerable tip	GW1850N
0.021in x 70cm Hydrophilic coated nitinol wire with steerable tip	GW2170N
0.035in x 80cm Hydrophilic coated nitinol wire with steerable tip	GW3580N

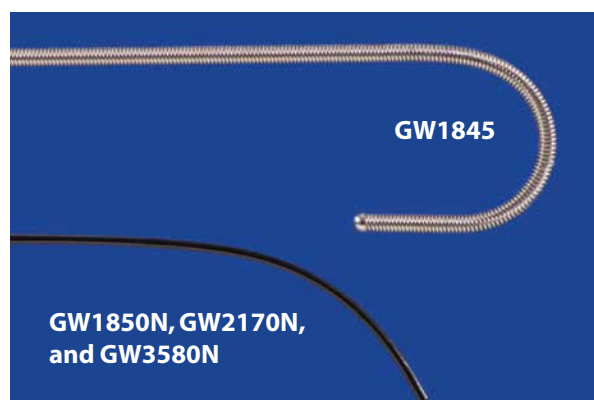

## Injection Port

- Neutral Displacement Injection Port PREVENTS BLOOD REFLUX into the catheter tip when disconnecting the syringe or line.
- CLAMPING IS NOT REQUIRED.
- SALINE FLUSH option reduces risk, cost, and time associated with Heparin use.
- Highly recommended to replace all previous style “bungles” and “prn ports” and “older model injection ports.”
- HIGHER FLOW RATE than previous ports.
- Used in all CVC kits.

ITEM # 8200

ITEM # 8099 Optional Stemless Cap



## Drum Long Line Catheter

### Catheter Through Catheter Introduction Style

- Kit includes catheter-over-needle introducer, a long catheter with stiffening wire and a drum.
- The Drum houses the long catheter, and is an advancement system designed to minimize touch contamination.
- Introduction technique: Long catheter through introducer catheter.
- The INTRODUCER CATHETER REMAINS INDWELLING, and the long catheter hub **locks** onto the introducer catheter hub. Since the introducer catheter remains indwelling, the long catheter can be easily replaced through the same introducer, avoiding another needle stick.
- Long catheter material is radiopaque kink-resistant polyurethane, embedded with a fluoro-polymer formula designed to aid in ease of placement.

DESCRIPTION	ITEM #
22Ga x 20cm (8in) with 20Ga Introducer	LLD2220
20Ga x 20cm (8in) with 18Ga Introducer	LLD2020
19Ga x 25cm (10in) with 16Ga Introducer	LLD1925

*Pick & Peel Drape (#PPD - \$3.90) recommended for sterile field, see page 9.*

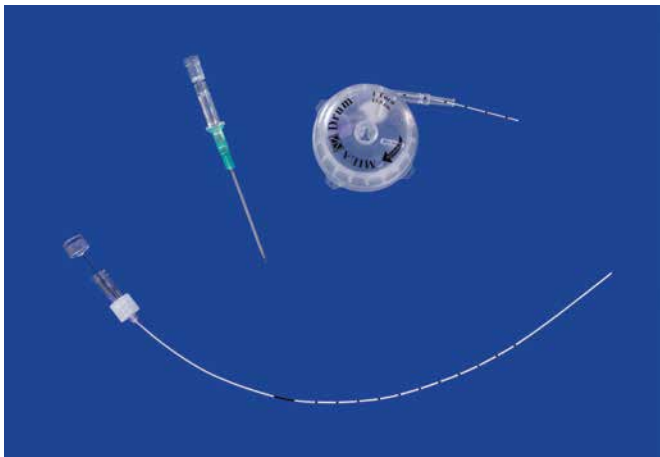

## Long Line Catheters

### Catheter Through Catheter Introduction Style

- Long term radiopaque catheter may be inserted in any vein.
- Polyurethane kink-resistant catheter can be cut to desired length.
- Female luer lock is placed onto long catheter after insertion into vessel, after the introducer catheter has been removed.
- Moveable wing provides method of secure attachment.
- Kit includes catheter, introducers, moveable suture wing (not available in LL2425), and female luer lock adapter.

DESCRIPTION	ITEM #
24Ga catheter adjustable up to 25cm (10in)	LL2425
20Ga catheter adjustable up to 45cm (18in)	LL2045
19Ga catheter adjustable up to 45cm (18in)	LL1945
19Ga catheter adjustable up to 90cm (36in)	LL1990

*Pick & Peel Drape (#PPD - \$3.90) recommended for sterile field, see page 9.*

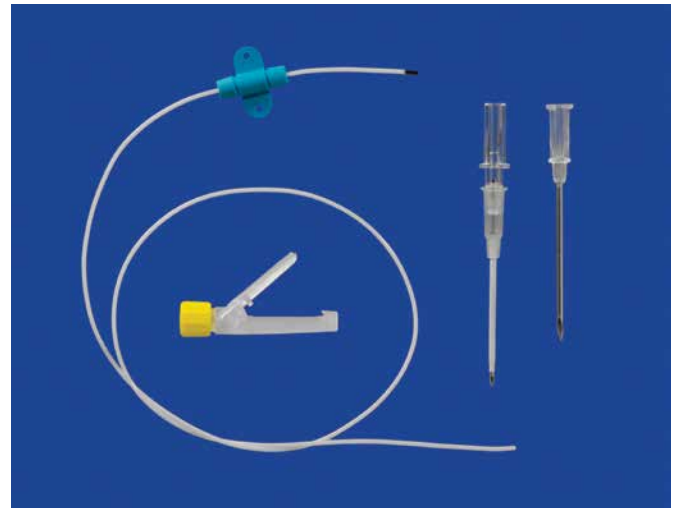

*See MILA website for link to YouTube video.*

## PICC - Silicone Catheter Kit

### Catheter Through Peel Away Introducer

- PICC - Peripherally Inserted Central Catheter.
- May be inserted in any vessel.
- Silicone material for long term use of 30 + days.
- Radiopaque catheter can be cut to desired length.
- Insertion method via peel away introducer.
- Catheter has a stylet wire to facilitate advancement.
- Kit includes catheter with wire stylet, peel away introducer, and tape measure.

DESCRIPTION	ITEM #
2Fr (23Ga) x 40cm (16in) Single Lumen	3240
3Fr (20Ga) x 60cm (24in) Single Lumen	3360
4Fr (18Ga) x 60cm (24in) Single Lumen	3460
5Fr (16Ga) x 60cm (24in) Single Lumen	3560
5Fr x 60cm (24in) Double Lumen (2-18Ga)	3565

See MILA website for link to YouTube video.

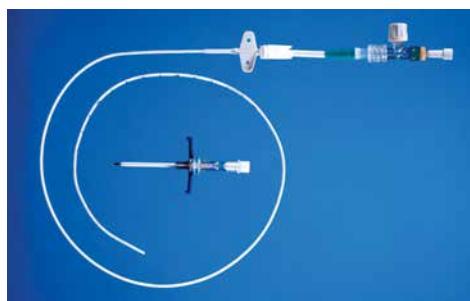

## CVP Manometer

35cm water manometer with four-way stopcock, 125cm (50 inch) extension, injection site and luer lock adapter.

ITEM #CVP35



## EZIO - Intraosseous Catheter Kit

- Emergency delivery of fluid, medications, and blood products directly into the vascular system within seconds, via bone marrow.
- Reusable stainless steel **two-part** needle. Solid sharp inner cannula. Consists of outer cannula with depth marks and forked tip.
- Very gentle. No bone splintering as with competitive systems.
- TRAINING needles are **non-sterile**. Sterilize with cold sterilant, autoclave, or EO Gas is recommended.
- **Re-use needles up to ten times.**
- Power driver has lithium sealed battery.

DESCRIPTION	ITEM #
Power Driver - G3	EZPD-3
Needle - 15Ga x 1.5cm	EZ1515
Needle - 15Ga x 2.5cm	EZ1525
Needle - 15Ga x 4.5cm	EZ1545
Training Needle - 15Ga x 1.5cm	EZTN15
Training Needle - 15Ga x 2.5cm	EZTN25
Training Needle - 15Ga x 4.5cm	EZTN45
Carrying Case - Soft Sided	EZC-S



*"We have found the EZIO very useful for patient care in our Emergency and Critical Care Department. It is easy to use and we train students, staff, house officers and faculty on clinical indications."*

Steven L. Marks BVSc, MS, MRCVS, DACVIM  
Clinical Professor of Internal and Emergency Medicine  
North Carolina State University

## Veincath Catheters

### Catheter Through Needle Introduction Style

- Innovative replacement for the VenoCath.™
- **Protective pouch** to advance catheter with stylet.
- After catheter is placed, the needle is safely discarded before easy attachment of the female luer.
- Economical, radiopaque.

DESCRIPTION	ITEM #
20Ga x 30cm (12in) catheter with 18Ga introducer	V2030



## Blood Filtration System

### FILTER

- Stainless steel filter designed to filter particulate within blood components down to 18 microns.
- Used for the filtration of stored blood components and other fluids indicated for filtration.
- Luer locking hub allows the use of a standard syringe without a needle.

DESCRIPTION	ITEM #
Hemo-Nate Blood Filter - 18 Micron	BF18

### SPIKE

- Hemo-Tap bag spike with needle injection port.

DESCRIPTION	ITEM #
Hemo-Tap Bag Spike	BF15



## Introducer Sheaths with Hemostatic Valve

- Vascular access introducer sheath with hemostatic valve.
- Complete hemostasis during insertion and withdrawal of devices.
- Advanced material improves flexibility without gapping or kinking.
- Quarter-turn-screw dilator locking system ensures the smooth transition from dilator to sheath, preventing the pull out of the dilator.
- Includes sheath, dilator, and 45cm hydrophilic coated Nitinol wire with angled tip.

DESCRIPTION	ITEM #
4Fr x 4cm (1.6in) - .021 wire	ISK4
5Fr x 5cm (2in) - .021 wire	ISK5
6Fr x 7cm (2.8in) - .035 wire	ISK6
7Fr x 7cm (2.8in) - .035 wire	ISK7
8Fr x 7cm (2.8in) - .035 wire	ISK8
9Fr x 7cm (2.8in) - .035 wire	ISK9

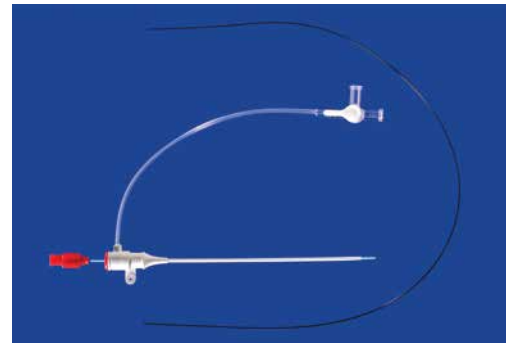

## Arterial Catheter

- Reliable guidewire introduction technique.
- 22Ga x 6cm (2.5in)
- Constructed of PTFE with flexible suture wing.
- Set includes 22Ga needle, wire, and catheter.

ITEM #AR2206



## Hemodialysis

- **Two equal 'D' shaped** lumens for optimal high blood flow.
- Staggered exit ports to reduce recirculation.
- Soft radiopaque catheter to minimize catheter kinking.
- Flexible tip design for ease of placement and to minimize risk of vascular trauma.
- Silicone extension lines for improved durability.
- Moveable clamp allows for anchoring at the insertion site.
- Rotating suture wing.
- Kit includes drape, scalpel, introducer, guidewire, dilator, catheter with silicone extensions and clamps, caps, suture wing, gauze and 2-0 suture.

DESCRIPTION	ITEM #
7Fr x 16cm (6.3in)	HDL716
8Fr x 16cm (6.3in)	HDL816
12Fr x 16cm (6.3in)	HDL1216
12Fr x 25cm (10in)	HDL1225



## Dispensing Pins

- Save time and money.
- Puncture bag stopper or vial only once for multiple withdrawals or injections.
- All are needle free. Operate with any syringe.
- PIN1 clamps onto the vial, eliminates pulling against a vacuum, and extends the life of the vial medication because all incoming air is filtered. Use on 20mm and 28mm vials.
- PIN3 greatly speeds up the process of filling syringes from a bag. The bag is punctured only once with the spike, thereby extending the life of the fluids when withdrawing from the bag through the needle free adapter, rather than through a needle.

DESCRIPTION	ITEM #
Clamping Vial Spike with Needle Free Valve and Filtered Inlet Vent	PIN1
Vial Spike with Needle Free Valve	PIN2
IV Bag Access with Needle Free Valve	PIN3

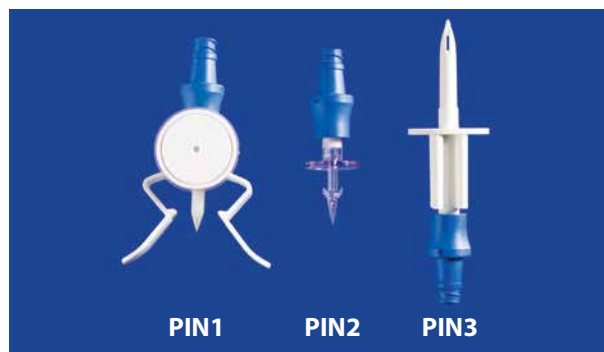

## Vented Vial Adapter

- Locks onto the vial.
- Pressure equalization.
- 0.2 micron bacteria filter for atmospheric air going into the closed system.
- 0.10ml priming volume.



DESCRIPTION	ITEM #
13mm vial	PIN13
20mm vial	PIN20
28mm vial	PIN28

## Extended Use MILACATH®

- Kink resistant and break resistant radiopaque polyurethane catheter-over-needle.
- Suture wing and suture groove.

DESCRIPTION	ITEM #
20Ga x 6.25cm (2.5in)	2011
18Ga x 6.25cm (2.5in)	1811
16Ga x 7.5cm (3.0in)	1603
16Ga x 13cm (5.25in)	1611
14Ga x 9cm (3.5in)	1403
14Ga x 13cm (5.25in)	1411
12Ga x 13cm (5.25in)	1211

Note: Extension sets and caps pictured on pages 16-20.

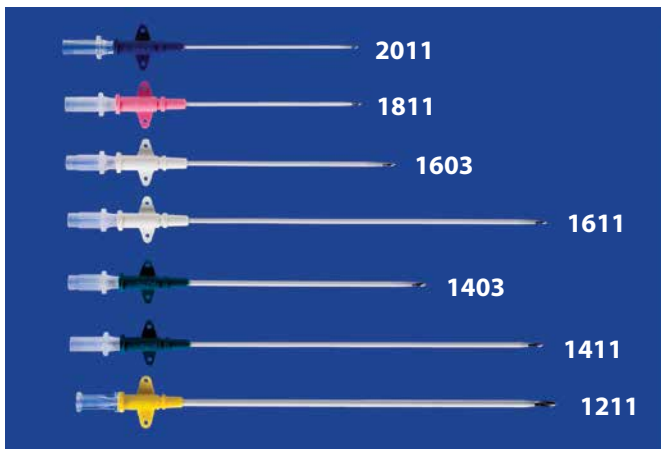
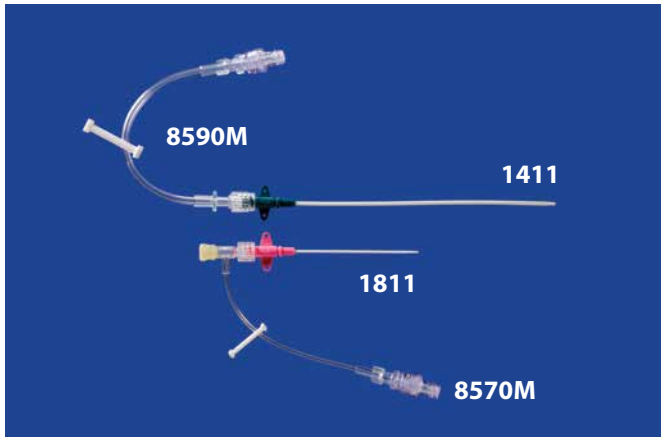

## Short Term Catheters

- Teflon radiopaque catheter-over-needle.

DESCRIPTION	ITEM #
26Ga x 20mm (.75in)	2675
22Ga x 45mm (1.75in)	2217
18Ga x 9cm (3.5in)	1804
16Ga x 7.5cm (3in)	1604
16Ga x 13cm (5.25in)	1612
14Ga x 7cm (2.75in)	1402
14Ga x 9cm (3.5in)	1404
14Ga x 13cm (5.25in)	1412
12Ga x 13cm (5.25in)	1212
10Ga x 15cm (6in) - polyurethane	1006

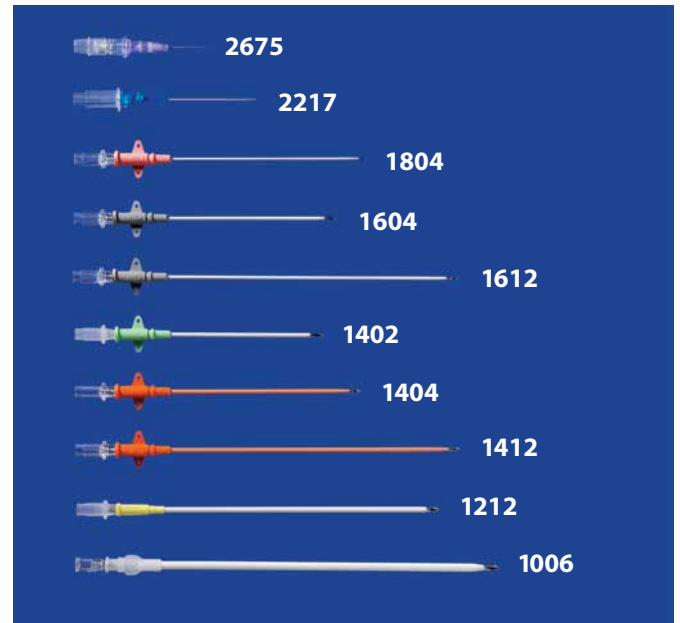

## Fenestrated Catheters

- Catheter-over-needle style with smooth transition from needle to catheter that aids in placement.
- Fenestrated with an additional 4 side holes at the distal end.
- Ideal for tapping pericardial effusion in dogs.

DESCRIPTION	ITEM #
18Ga x 5cm (2.5in)	1802F
18Ga x 9cm (3.5in)	1804F
16Ga x 7.5cm (3in)	1604F
14Ga x 9cm (3.5in)	1404F
14Ga x 13cm (5.25in)	1412F
12Ga x 13cm (5.25in)	1212F

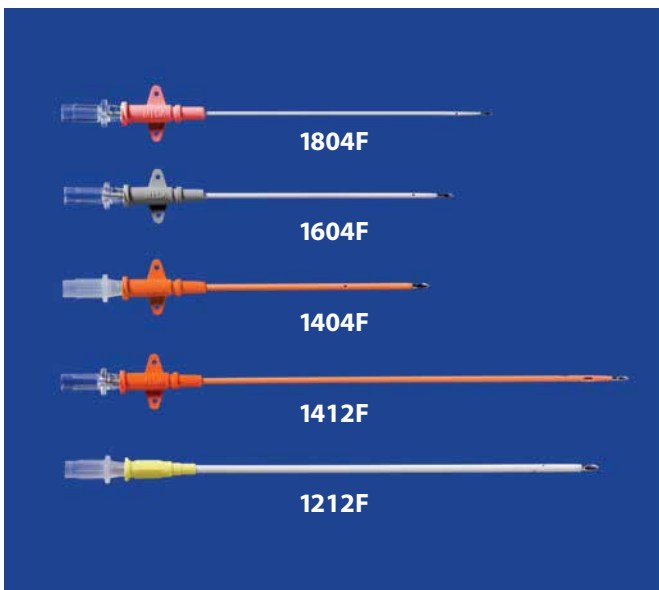
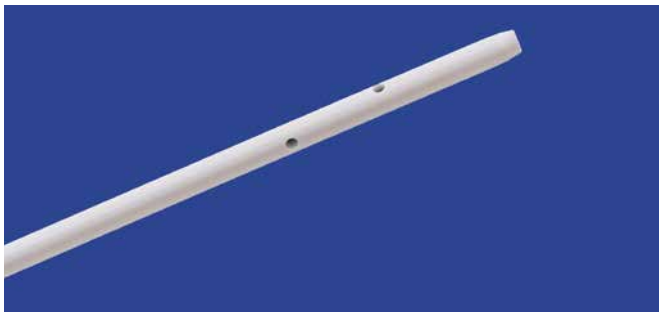

## Introcan® Safety™ Catheters

- Quality smooth transition from needle to catheter reduces burring and wasted sticks.
- Introcan® Safety™ radiopaque polyurethane catheters feature a safety clip that automatically covers the needle point when it is withdrawn, reducing accidental needle sticks.
- Push-off plate on hub for smooth insertion.
- Guarded flashback chamber.

DESCRIPTION	ITEM #
24Ga x 19mm (.75in)	IC2475
22Ga x 25mm (1.0in)	IC2201
20Ga x 32mm (1.25in)	IC2001
18Ga x 45mm (1.75in)	IC1801



NEW



### 360° SPINNER LUER LOCK\*

- **360° spinning luer lock hub** resists twisting and kinking of the catheter during horse movement.
- Helps prevent catheter disconnects by allowing the extension line to spin freely **360°** when connected to a catheter. Avoids accidental unscrewing.
- Easily position the extension set dorsal or ventral to allow catheter wings to lay flat against the horse for improved stabilization.
- Item numbers 8518 and 8590 feature the 360° spinning luer lock hub. Item numbers 8518M, 8530M, 8550M, 8590M feature the stasis valve and the 360° spinning luer lock hub. Item numbers 8700 and 8718 feature a large bore female luer and 360° spinning luer lock hub.



### STASIS VALVE

- **The neutral displacement stasis valve prevents blood reflux into the catheter when connecting and disconnecting syringes/lines.**
- **Does not require clamping to control valve induced reflux.**
- **Closed, needle free valve with a flat, swabable top for easy disinfecting.**
- **Saline flush** option reduces risk, cost, and time associated with Heparin use. **Heparin not required.**
- **Higher flow rate** than Microclave.
- Included in item numbers 8518M, 8530M, 8550M 8572M, 8575M, 8590M.



### LARGE BORE FEMALE LUER

- Large bore, female luer.
- Included in item numbers 8700 and 8718.



### ROTATING MALE LUER LOCK

- Large bore, rotating luer lock.
- Included in item numbers 8572, 8575, 8572M, 8575M.

\*Patent Pending



## Large Bore Extension Sets

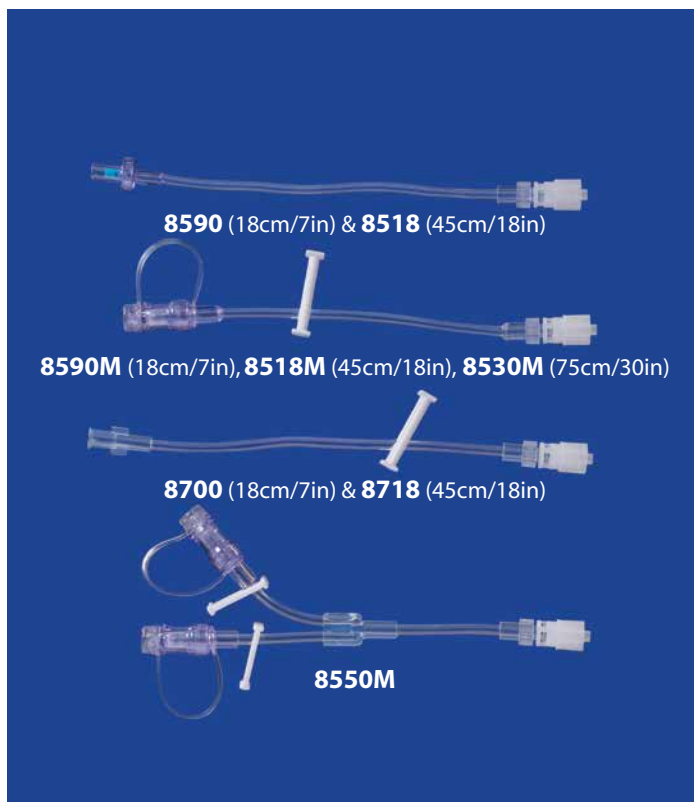

DESCRIPTION	ITEM #
Normally Closed Valve, and 360° Spinner	
13Ga x 18cm (7in)	8590
13Ga x 45cm (18in)	8518
Stasis Valve, Clamp, Tethered Cap, and 360° Spinner	
13Ga x 18cm (7in)	8590M
13Ga x 45cm (18in)	8518M
13Ga x 75cm (30in)	8530M
Female Luer, Clamp, and 360° Spinner	
13Ga x 18cm (7in)	8700
13Ga x 45cm (18in)	8718
Stasis Valve, Y Extension, Clamps, Tethered Caps, and 360° Spinner	
12Ga x 15cm (6in)	8550M

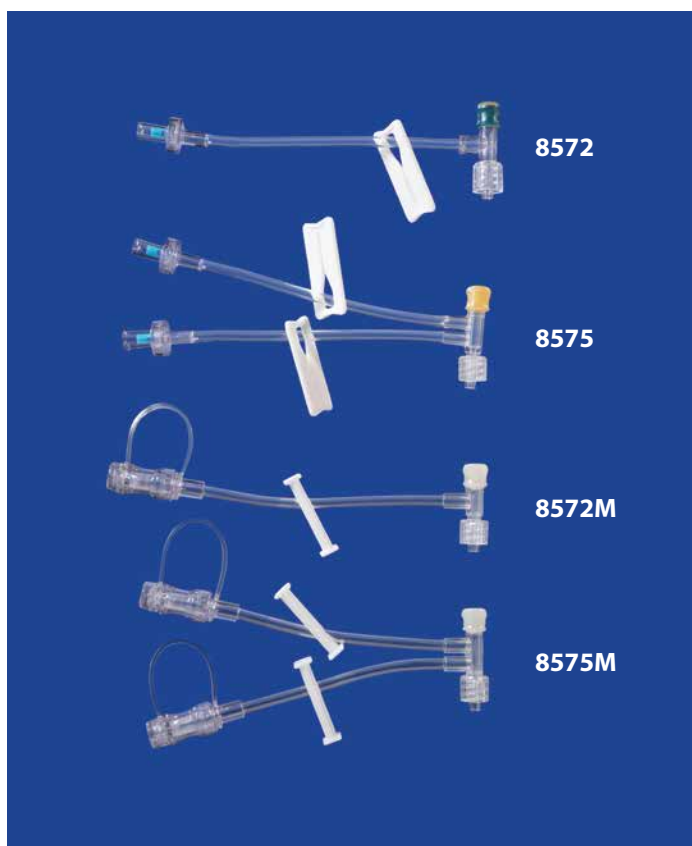

DESCRIPTION	ITEM #
T-Set with Normally Closed Valve, Injection Site, Clamp, and Rotating Male Luer Lock	
12Ga x 12.75cm (5in)	8572
Double T with Normally Closed Valves, Injection Site, Clamps, and Rotating Male Luer Lock	
12Ga x 12.75cm (5in)	8575
T-Set with Stasis Valve, Injection Site, Clamp, and Rotating Male Luer Lock	
12Ga x 12.75cm (5in)	8572M
Double T with Stasis Valves, Injection Site, Clamps, and Rotating Male Luer Lock	
12Ga x 12.75cm (5in)	8575M

**NEW****STASIS VALVE**

- The neutral displacement stasis valve prevents blood reflux into the catheter when connecting and disconnecting syringes/lines.
- Does not require clamping to control valve induced reflux.
- Closed, needle free valve with a flat, swabable top for easy disinfecting.
- Saline flush option reduces risk, cost, and time associated with Heparin use. **Heparin not required.**
- **Higher flow rate** than Microclave.
- Included in item numbers 8570M, 8573M, 8574M, 8576M, 8577M, 8585M.

**MICROCLAVE®**

- One-piece, closed, needle free connector.
- Approved for saline flush. **Heparin not required.**
- Included in item numbers MC40, MC43, MC44.

**NORMALLY CLOSED VALVE**

- The valve is bi-directional for infusion and sampling.
- Small bore tubing.
- Select caps on page 20, or connect to an IV line.
- Included in item numbers 8570 and 8585.

**FEMALE LUER AND ROTATING MALE LUER LOCK**

- Small bore, mini bore, and pressure tubing with female luer.
- Rotating male luer lock.
- Select caps on page 20, or connect to an IV line.
- Included in item numbers 8509, 8515, 8540, 8541, 8544, 8545.

## Small Bore Extension Sets



DESCRIPTION	ITEM #
T-Set with Injection Site, Clamp, Rotating Male Luer Lock, Tethered Cap 16Ga x 13cm (5in)	8570M
T-Set with Injection Site, Clamp, Luer Slip, Tethered Cap 16Ga x 13cm (5in)	8573M
Y-Set with Clamps, Rotating Male Luer Lock 16Ga x 13cm (5in)	8574M
T-Set with Dual Valves, Injection Site Clamps, Tethered Caps, Luer Slip 16Ga x 20cm (8in)	8576M
T-Set with Dual Valves, Injection Site, Rotating Male Luer Lock, Clamps, Tethered Caps 16Ga x 20cm (8in)	8577M
Single Lumen, Clamp, 360° Spinner, Tethered Cap 16Ga x 18cm (7in)	8585M



DESCRIPTION	ITEM #
T-Set with MicroClave, Injection Site, Clamp, Rotating Luer Lock (18cm/7in length)	MC40
T-Set with dual MicroClaves, Injection Site, Clamp, Rotating Luer Lock (18cm/7in length)	MC43
Bifuse 'Y' Set with three Clamps, Rotating Luer Lock (18cm/7in length)	MC44

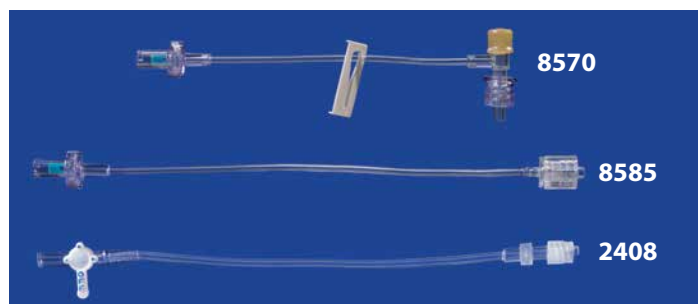



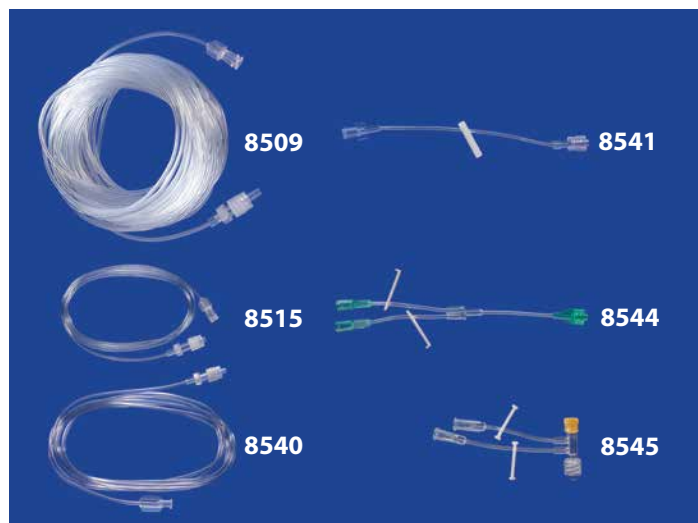

DESCRIPTION	ITEM #
T-Set with Clamp and Rotating Luer Lock 16Ga x 12.75cm (5in)	8570
Single Lumen with Rotating Luer Lock 16Ga x 18cm (7in)	8585
Three-way Stopcock with 8in Extension	2408



DESCRIPTION	ITEM #
Nano Bore - 20Ga x 9.1m (30ft) Priming Volume = 4.0 ml	8509
Pressure Monitoring Extension - 16Ga x 180cm (72in) Priming Volume = 3.4 ml	8515
Small Bore - 20Ga x 100cm (40in) Priming Volume = 1.0 ml	8540
Mini Bore Extension - 20Ga x 15cm (6in) Priming Volume = 0.3 ml	8541
Y Extension Set Priming Volume = 0.43 ml	8544
Double T Extension Set Priming Volume = 0.4 ml	8545

## Injection Ports

FEATURE	Item #8200*	Item #8098	Item #8095	Item #8080
*Item #8200 recommended for all applications.				
Needle Free, Swabable	✓	✓	✓	
Neutral Displacement	✓			
Bi-Directional	✓	✓	✓	
Approved for Saline Flush	✓	✓		
High Flow	✓		✓	
Normally Closed	✓	✓	✓	✓
Safety, Built-in Stop	NA	NA	NA	✓

- **#8200 - Neutral Displacement (Stasis) Injection Port** prevents blood reflux. Does not require clamping to control valve induced reflux. **The saline flush** option reduces risk, cost, and time associated with Heparin use. Higher flow rate than the MicroClave.
- **#8098 - MicroClave** is a one-piece, closed, needle free connector. Labeled for saline flush. Heparin not required.
- **#8095 - Bi-Directional Injection Port** for direct attachment of an IV line or syringe. Includes a tethered cap (8090).
- **#8080 - Safety Injection Port** has a built-in stop to prevent accidental tubing or technician puncture.

DESCRIPTION	ITEM #
Neutral Displacement (Stasis) Injection Port	8200
MicroClave Needle Free Injection Port	8098
Bi-Directional Valve Cap (includes 8090)	8095
Safety Injection Port	8080

## Caps

- **Tethered Cap** (8090) attaches to the catheter or extension hub to cover the injection port. Not for needle free valves.
- **Stemless Luer Lock Cap** (8099) 10 pack, non-sterile. Universal, works with all injection ports.

DESCRIPTION	ITEM #
Tethered Cap	8090
Stemless Luer Lock Cap (10 pack)	8099

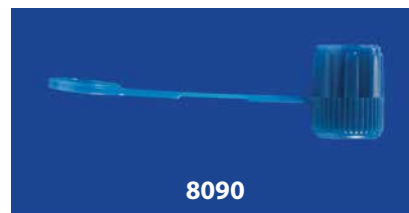

## Aspiration Needle System for FLUID

- Designed to provide intraosseous access and quality fluid aspirates.
- Triple sharpened tip to allow a non-traumatic, fast penetration into the bone marrow cavity.
- Adjustable depth guard to help control depth during needle insertion.
- Luer lock connection for syringe.

DESCRIPTION	ITEM #
18Ga x 2cm (.78in) - Pink	BMAN18
15Ga x 3cm (1.25in) - Blue	BMAN15



BMAN18

BMAN15

## Bone Marrow Aspiration Needle System for SOLIDS

- Designed to provide quality biopsies by capturing and retaining the bone marrow in the needle ***WITHOUT ALTERING THE SAMPLE.***
- System includes Jamshidi style biopsy needle, obturator pushing rod, probe guide and luer lock cap.
- Needle point allows for easy penetration into the marrow cavity.
- Marked obturator rod indicates length of specimen prior to extraction and can be used to expel specimen from the extraction cannula.
- Luer lock connection for syringe.

DESCRIPTION	ITEM #
13Ga x 10cm (4in) - Blue	BMAN13
11Ga x 10cm (4in) - White	BMAN11
8Ga x 10cm (4in) - Green	BMAN8



## Soft Tissue Biopsy Needle

- **Echogenic tip** for accurate placement under ultrasound guidance.
- Centimeter markings facilitate precise depth placement.
- Specimen depth notch is adjustable to 15mm or 22mm.
- Can be safely positioned in the lesion before the spring loaded cutting cannula is deployed.
- Spring activated single-hand operation for soft tissue core biopsy collection.
- Precision cutting helps preserve cellular architecture for more accurate diagnosis.

DESCRIPTION	ITEM #
14Ga x 8cm (3in)	BN1408
14Ga x 15cm (6in)	BN1415
16Ga x 8cm (3in)	BN1608
16Ga x 15cm (6in)	BN1615



## Shores-Little Cerebral Biopsy Device

- Designed to obtain quality biopsies from deep or superficial cerebral structures.
- Includes biopsy sleeve, stylet, extension set, and 5cc syringe.
- Placement is guided by intraoperative ultrasound imaging or direct visualization of the target tissue.
- Sterile, single use.

DESCRIPTION	ITEM #
16Fr x 10.5cm (4.1in)	SLCBD1



## Tomcat / Small Animal Urinary Catheter – Length Adjustable

- **One catheter replaces two.** Same catheter used to unblock and leave indwelling to drain the bladder. This single device technique is designed to reduce the risk of infection and trauma associated with a two catheter technique.
- **FLUSHING STYLET** (optional) enables flushing through the stylet during insertion.
- Moveable new suture device allows length adjustment.
- Non-irritating radiopaque polyurethane material with a finished open tip. Catheter is rigid for easy insertion and softens with body temperature.
- Improvement to the standard Tomcat, Jackson and Slippery Sam™ urinary catheters.
- Finished open tip.
- Luer lock for secure attachment to a **CLOSED COLLECTION SYSTEM** (see page 23).
- The 25cm length allows for the most flexibility when securing the catheter. The additional length allows for securement of the collection bag connector to occur at the tail or back of the cat, resulting in minimal catheter tension at the prepuce when the cat moves.

DESCRIPTION	ITEM #
3.5Fr - catheter, length adjustable up to 15cm (6in)	UC306
3.5Fr - catheter, length adjustable up to 15cm (6in), with stylet	UC306S
3.5Fr - catheter, length adjustable up to 25cm (10in)	UC310
3.5Fr - catheter, length adjustable up to 25cm (10in), with stylet - <b>most versatile size</b>	UC310S
5Fr - catheter, length adjustable up to 15cm (6in)	UC506
5Fr - catheter, length adjustable up to 15cm (6in), with stylet	UC506S
5Fr - catheter, length adjustable up to 25cm (10in)	UC510
5Fr - catheter, length adjustable up to 25cm (10in), with stylet	UC510S

See page 23 for Urine Collection options | See page 24 for 4Fr Foley Catheter - **NEW**

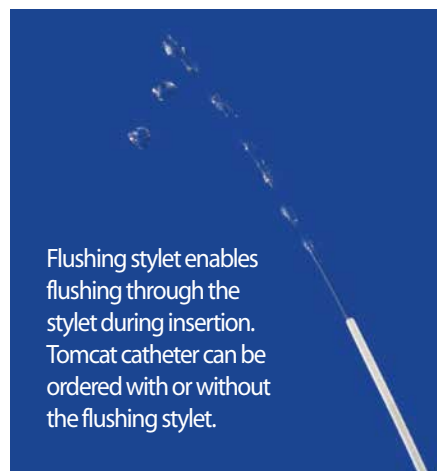
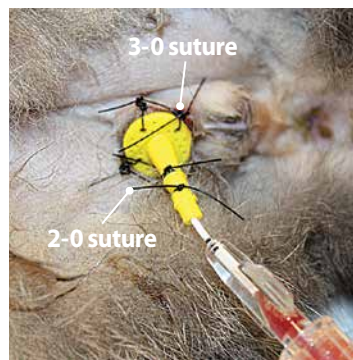
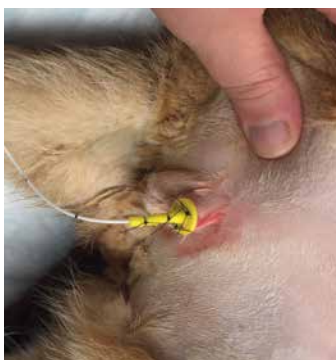

Flushing stylet enables flushing through the stylet during insertion. Tomcat catheter can be ordered with or without the flushing stylet.



## Closed System Urine Collection Kits and Replacement Bags

DESCRIPTION	ITEM #
<b>600cc closed system</b> including 600cc collection bag with anti-reflux valve and twist drain, 72in (180cm) lightweight collection line with 360° spinner luer lock, injection/sampling port, and female christmas tree adapter.	UC600K
<b>1000cc closed system</b> including 1000cc collection bag with anti-reflux valve and twist drain, 72in (180cm) lightweight collection line with 360° spinner luer lock, injection/sampling port, and female christmas tree adapter.	UC1000K



### 360° SPINNER LUER LOCK ON THE COLLECTION LINE

**360° spinning luer lock hub** resists twisting and kinking of the collection line. Avoids accidental unscrewing.

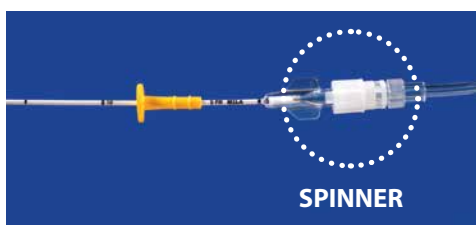
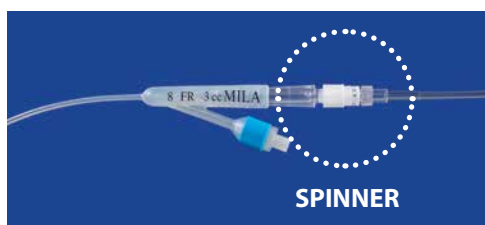

<b>2000cc closed system</b> including 2000cc collection bag with anti-reflux valve and push/pull drain, 72in (180cm) collection line, injection/sampling port, non-wetable air filter, and integrated barbed adapter.	UC2000K
---	---------

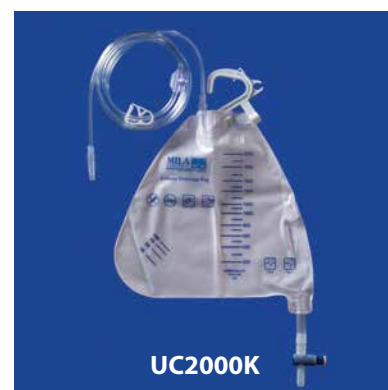

## FOAL Closed System – CUSTOMIZABLE

**Choose a collection bag and extension set to create a closed collection system for a foal. Consider tech convenience for size of foal, ambulatory, recumbent, etc.**

<b>BAGS</b> 600cc Collection Bag - Improved with volume marks beginning with 50cc, male luer lock, and twist drain.	UC600
1000cc Collection Bag - Improved with volume marks beginning with 25cc, male luer lock, and twist drain.	UC1000
<b>EXTENSION SETS</b> 7, 18, and 30in lengths include Stasis Valve, Clamp, Tethered Cap, and 360° spinner luer lock.	
13Ga x 18cm (7in)	8590M
13Ga x 45cm (18in)	8518M
13Ga x 75cm (30in)	8530M
72in length includes lightweight tubing, injection/sampling port, and 360° spinner luer lock.	UCT



## Replacement Bags and Collection Line

600cc Collection Bag - Improved with volume marks beginning with 50cc, male luer lock, and twist drain.	UC600
1000cc Collection Bag - Improved with volume marks beginning with 25cc, male luer lock, and twist drain.	UC1000
Lightweight collection line (180cm/72in) with an injection/sampling port and 360° spinner luer lock.	UCT

## Foley Catheters with Wire Stylet in a Procedure Kit

- **Kit** includes radiopaque silicone foley catheter, wire stylet, suture wing, suture pack, female luer lock christmas tree, cap, lubricating gel packet, gauze, and syringe.
- Water activated lubricant on **inside** of sizes 5, 6 and 8 facilitates wire removal.
- Balloon cuff retains catheter in the bladder.
- The stylet provides rigidity to save time and trauma.

DESCRIPTION	ITEM #
4Fr x 30cm (12in) with 1cc balloon - <i>NEW</i>	UC412
5Fr x 30cm (12in) with 1cc balloon	UC512
5Fr x 55cm (21in) with 1cc balloon	UC521
6Fr x 30cm (12in) with 1.5cc balloon, suture wing	UC612
6Fr x 60cm (24in) with 1.5cc balloon, suture wing	UC624
6Fr x 90cm (36in) with 1.5cc balloon, suture wing	UC636
8Fr x 30cm (12in) with 3cc balloon, suture wing	UC812
8Fr x 60cm (24in) with 3cc balloon, suture wing	UC824
8Fr x 90cm (36in) with 3cc balloon, suture wing	UC836
10Fr x 30cm (12in) with 5cc balloon, suture wing	UC1012
10Fr x 45cm (18in) with 5cc balloon, suture wing	UC1018
10Fr x 90cm (36in) with 5cc balloon, suture wing	UC1036



## Foley Catheters with Wire Stylet

- Radiopaque silicone foley catheter **with wire stylet**, suture wing, female luer lock christmas tree, and cap.

DESCRIPTION	ITEM #
12Fr x 30cm (12in) with 10cc balloon	UC1212
12Fr x 55cm (21in) with 10cc balloon	UC1221
14Fr x 23cm (9in) with 10cc balloon	UC1409
14Fr x 55cm (21in) with 10cc balloon	UC1421
16Fr x 55cm (21in) with 10cc balloon	UC1621
18Fr x 55cm (21in) with 10cc balloon	UC1821
20Fr x 55cm (21in) with 10cc balloon	UC2021
22Fr x 55cm (21in) with 10cc balloon	UC2221
24Fr x 42cm (16in) with 30cc balloon	UC2416
24Fr x 150cm (59in) with 30cc balloon	UC2459

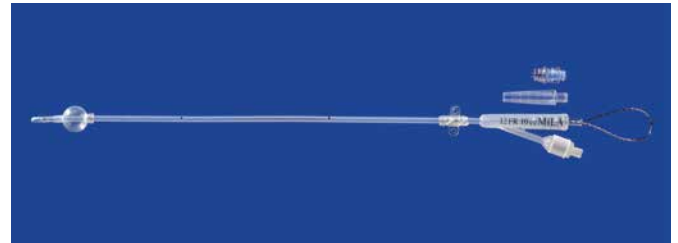

## Foley Catheters without Wire Stylet

- Radiopaque silicone catheter only, **no stylet**. Includes suture wing, female luer lock christmas tree, and cap.

DESCRIPTION	ITEM #
12Fr x 30cm (12in) with 10cc balloon	UC1212C
12Fr x 55cm (21in) with 10cc balloon	UC1221C
14Fr x 23cm (9in) with 10cc balloon	UC1409C
14Fr x 55cm (21in) with 10cc balloon	UC1421C
16Fr x 55cm (21in) with 10cc balloon	UC1621C
18Fr x 55cm (21in) with 10cc balloon	UC1821C
20Fr x 55cm (21in) with 10cc balloon	UC2021C
22Fr x 55cm (21in) with 10cc balloon	UC2221C
24Fr x 42cm (16in) with 30cc balloon	UC2416C
24Fr x 150cm (59in) with 30cc balloon	UC2459C

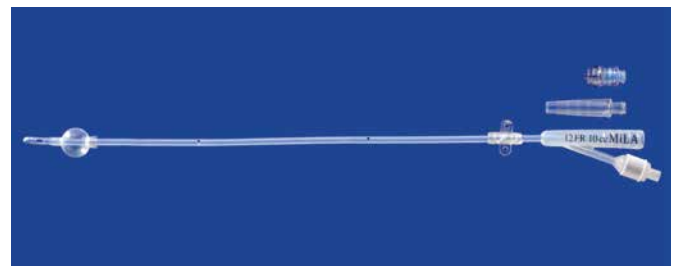



## Foley Catheters for Female Canine Guidewire/Seldinger Insertion

- Guidewire inserted foley catheter for female dogs.
- **Open ended** foley catheter with balloon cuff.
- Hydrophilic Nitinol guidewire with angled tip.
- Water activated lubricant facilitates wire removal.
- Introducer with depth markings and flexible tip.
- Radiopaque silicone material.
- Kit includes catheter, guidewire, dilator, drape, lubricant, suture, suture wing, female luer lock christmas tree, cap, gauze, and syringe.

DESCRIPTION	ITEM #
6Fr x 35cm (14in) with 1.5cc balloon	UCG610
8Fr x 35cm (14in) with 3cc balloon	UCG810



*"I strongly believe this improvement will help enormously with a much easier and safer placement of a urinary foley catheter in female dogs. And most importantly, it will offer better control of hygiene during catheter placement."*

Developed in cooperation with Joris Robben, Associate Professor in Emergency and Intensive Care Medicine at the Small Animal ICU of the Faculty of Veterinary Medicine of Utrecht University

## Foal/Horse Foley Catheters and Foal Urine Collection Kit

- Balloon cuff retains catheter in the bladder.
- The wire provides rigidity to save time and trauma.
- Radiopaque silicone material.
- 8Fr and 10Fr sizes packaged in a kit with catheter, wire stylet, suture wing, suture pack, female luer lock christmas tree, cap, lubricating gel packet, gauze, and syringe.
- 12Fr to 24Fr include wire stylet, female luer lock christmas tree, suture wing, and cap.

DESCRIPTION	ITEM #
8Fr x 30cm (12in) with 3cc balloon	UC812
8Fr x 60cm (24in) with 3cc balloon	UC824
8Fr x 90cm (36in) with 3cc balloon	UC836
10Fr x 30cm (12in) with 5cc balloon	UC1012
10Fr x 45cm (18in) with 5cc balloon	UC1018
10Fr x 90cm (36in) with 5cc balloon	UC1036
12Fr x 30cm (12in) with 10cc balloon	UC1212
12Fr x 55cm (21in) with 10cc balloon	UC1221
14Fr x 23cm (9in) with 10cc balloon	UC1409
14Fr x 55cm (21in) with 10cc balloon	UC1421
16Fr x 55cm (21in) with 10cc balloon	UC1621
18Fr x 55cm (21in) with 10cc balloon	UC1821
20Fr x 55cm (21in) with 10cc balloon	UC2021
22Fr x 55cm (21in) with 10cc balloon	UC2221
24Fr x 42cm (16in) with 30cc balloon	UC2416
24Fr x 150cm (59in) with 30cc balloon	UC2459

Customizable Foal Urine Collection products on page 23.



## PERCUTANEOUS Balloon Catheter Kit for Cystostomy and Gastrotomy

- **Introduction uses Seldinger wire, followed by peel away sheath.**
- **Open ended** silicone catheter with 20cc balloon, depth markings, and radiopaque stripe.
- 20Fr x 25cm (10in) catheter with Y-port and fixation ring.
- **Short catheter tip** design reduces gastric mucosa irritation.
- Large funnel Y-port with locking caps.
- Adjustable fixation ring prevents catheter migration.
- Kit includes catheter, catheter-over-needle introducers, guidewire, peel away sheath with dilator, 12Fr dilator, scalpel, drape, gauze, suture, and syringe.

ITEM #PBC20



## Locking Pigtail Catheter Kit (Nephrostomy)

- Percutaneous cannula-over-needle placement facilitates controlled, minimally invasive catheter introduction.
- For emergency nephrostomy and abscess drainage.
- Soft, flexible, kink resistant, radiopaque polyurethane catheter.
- Side holes positioned within catheter pigtail for effective drainage.
- **Locking string system** to secure pigtail/catheter in place.
- Includes cannula, direct puncture needle, pigtail catheter, collection line, and 600cc collection bag.

DESCRIPTION	ITEM #
6Fr x 30cm (12in)	PT625
8Fr x 30cm (12in)	PT825

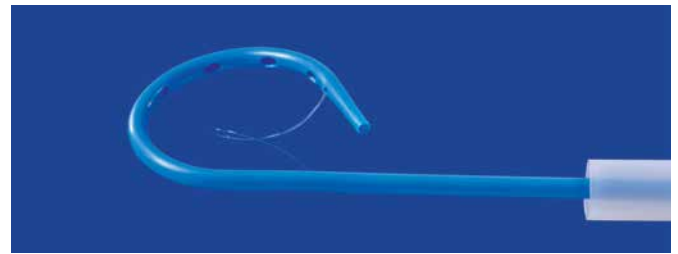

## Cystostomy/Gastrotomy Catheter

- **SURGICALLY PLACED** open ended silicone catheter with 20cc balloon, radiopaque stripe, fixation ring, and Y-port. Clamp included.

DESCRIPTION	ITEM #
20Fr x 25cm (10in)	CYGA20
24Fr x 25cm (10in)	CYGA24



## Anal Sac Lifting Catheter

Lifting Catheter for Surgeons

- Use for anal saccullectomy.
- Silicone catheter and balloon construction.
- Stiff low profile tip allows catheter to navigate into the anal sac orifice.

DESCRIPTION	ITEM #
4Fr x 17.5cm (7in) - 1cc balloon	SAC4
6Fr x 17.5cm (7in) - 3cc balloon	SAC6

See MILA website for link to YouTube video.

*Anal Saccullectomy procedure video complimentary of J. Brad Case, DVM, MS, DACVS, Assistant Professor, University of Florida Department of Small Animal Clinical Sciences*

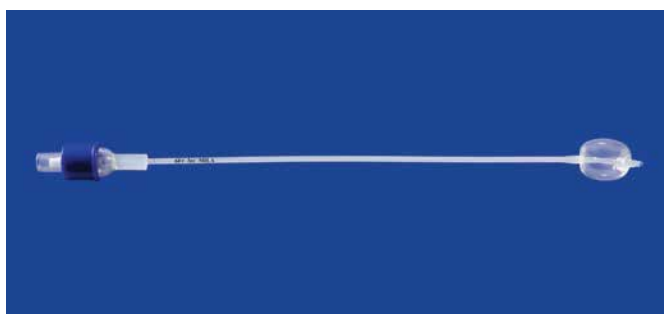

## Olive Tip Needles

### URINARY & ANAL GLAND LAVAGE NEEDLE

- Used to flush and lavage distal end of feline penis and anal gland.
- Stainless steel needle with small atraumatic olive tip.
- Female luer designed to fit any syringe.

DESCRIPTION	ITEM #
21Ga x 1.3cm (0.5in)	OT2113
21Ga x 2.5cm (1.0in)	OT2125
21Ga x 4.0cm (1.5in)	OT2140

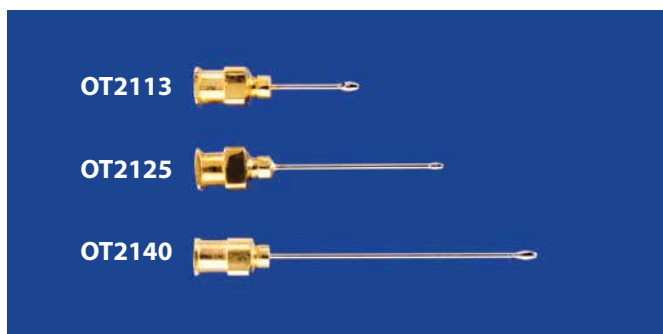

## Canine GDV / Bloat Tube

- **Dual lumen** tube for simultaneous flushing and evacuation of the stomach in Emergency and Surgery.
- Four large side holes.
- Soft, heavy duty silicone material.
- **Reusable.**
- Atraumatic tip.

DESCRIPTION	ITEM #
Giant Breed 30mm (1.2in) OD x 22mm (1in) ID 180cm (72in) length, Flushing lumen = 50in	GDV1
Large Breed 25mm (1.0in) OD x 18mm (.7in) ID 180cm (72in) length, Flushing lumen = 50in	GDV2
<b>NEW</b> Medium Breed 17mm (0.6in) OD x 12mm (.48in) ID 180cm (72in) length, Flushing lumen = 32in	GDV3L
Medium Breed 17mm (0.6in) OD x 12mm (.48in) ID 125cm (50in) length, Flushing lumen = 32in	GDV3
Small Breed 12mm (0.48in) OD x 8.7mm (.34in) ID 125cm (50in) length, Flushing lumen = 32in	GDV4

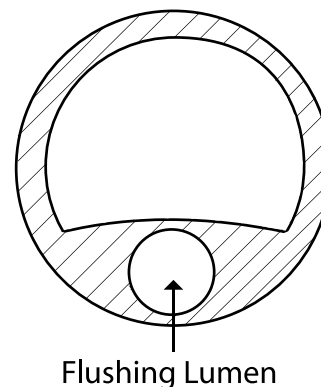
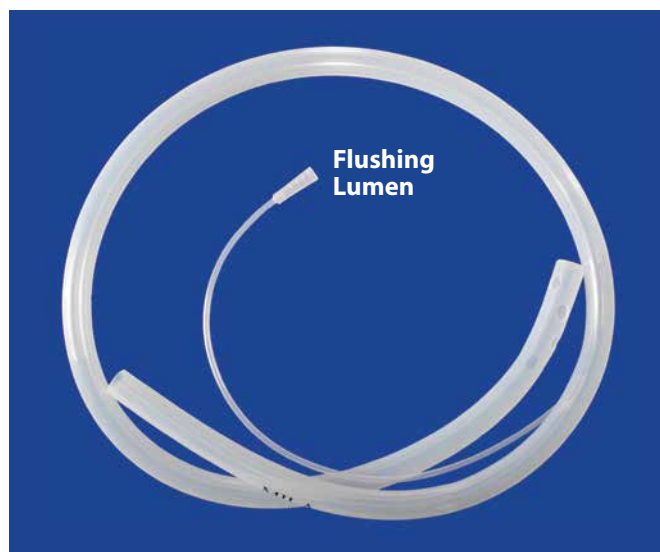

## Pink Poly™ – The Red Rubber Improvement

Everyday Economy  
for Short Term Use

- Use for NG feeding, esophagostomy tube, urine drainage, oxygen delivery, and small animal BAL.
- DEHP and PHTHalate Free: Non-Leaching, non-irritating, latex free polymer (PVC) construction that becomes firm when cold. Softens with body temperature.
- Clear catheter body. Designed to easily visualize contents within the catheter.
- Smooth, polished surface inside and out. Minimizes trauma during catheter insertion and removal.
- Radiopaque Pink Stripe eliminates need for contrast. Entire catheter of #PP316 (3.5Fr) completely radiopaque.
- Centimeter markings on 8Fr-18Fr for precise depth placement.
- Longer lengths for 8Fr, 10Fr, and 12Fr, are adequate for male dogs and for small animal BAL.
- Staggered eyelets help to maintain tip strength during insertion and promote efficient drainage. Rounded, closed tip.
- Female luer hub eliminates need for barbed adapter. Connect **DIRECTLY** to your syringe or collection set.

DESCRIPTION	HUB STYLE	ITEM #
3.5Fr x 41cm (16in)	Female Luer	PP316
5Fr x 41cm (16in)	Female Luer	PP516
8Fr x 41cm (16in)	Female Luer	PP816
8Fr x 56cm (22in)	Female Luer	PP822
8Fr x 108cm (42.5in)	Female Luer	PP842
10Fr x 41cm (16in)	Female Luer	PP1016
10Fr x 56cm (22in)	Female Luer	PP1022
10Fr x 108cm (42.5in)	Female Luer	PP1042
12Fr x 41cm (16in)	Funnel	PP1216
12Fr x 56cm (22in)	Female Luer	PP1222
14Fr x 41cm (16in)	Funnel	PP1416
18Fr x 41cm (16in)	Funnel	PP1816

Each individually packaged and sterile.

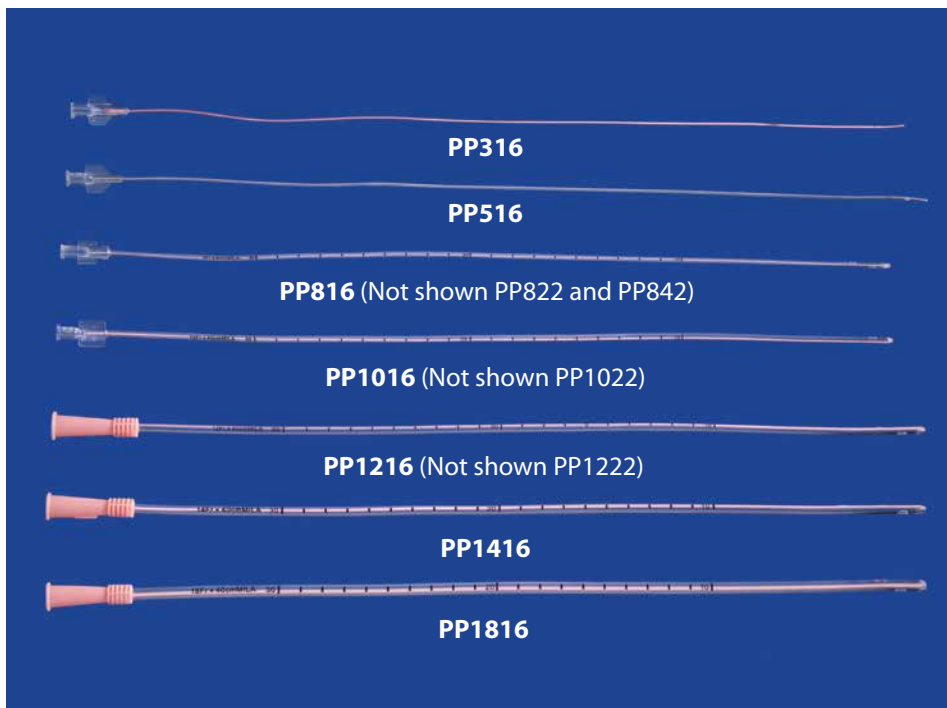

## Pink Poly™ – Catheter Connectors

- Christmas tree adapters for use with luer lock or funnel.
- Female luer enables direct connection to a syringe or collection set.

DESCRIPTION	BOX SIZE	ITEM #
Large dual ends to fit 12 - 36Fr tubes	10	2300
Small end fits 12 - 18Fr tubes. Large end fits 22 - 33Fr tubes	10	2320
Male Luer Lock with adapter to fit 11 - 22Fr tubes	10	2370
Male Luer Lock with adapter to fit 20 - 40Fr tubes	10	2380

*Each individually packaged and sterile.*



## Gastrotomy Kits

- Radiopaque polyurethane material is non-irritating and stronger than silicone.
- Collapsible bumper to facilitate insertion and removal. **Less traumatic removal than mushroom style.**
- Right angle fixation device that holds tube securely.
- Locking Y-adapter for feeding, irrigation, decompression and medication without disconnection.
- In large dogs, suture the disk securely.

### SURGICAL PLACEMENT

**Surgical Kit** includes 50cm (20in) PEG tube, right angle fixation device, silicone fixation bar, Y-adapter, and clamp.

DESCRIPTION	ITEM #
16Fr Surgically Placed Kit	PGS16
20Fr Surgically Placed Kit	PGS20

### ENDOSCOPIC PLACEMENT

**Endoscopic Kit** includes introducer needle, guidewire with loop, 62.5cm (25in) PEG tube with loop, right angle fixation device, silicone fixation bar, Y-adapter and clamp.

DESCRIPTION	ITEM #
16Fr Endoscopically Placed Kit	PEG16
20Fr Endoscopically Placed Kit	PEG20

### REPLACEMENT PIECES

Y-Replacement - 16Fr	RPEG16
Y-Replacement - 20Fr	RPEG20

See MILA website for link to YouTube video.

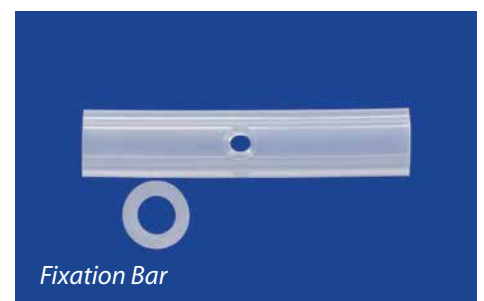
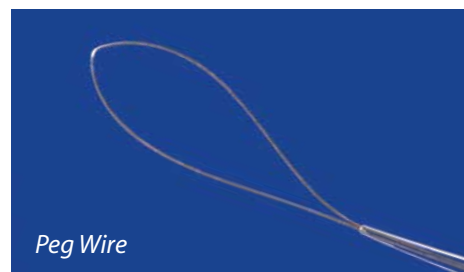
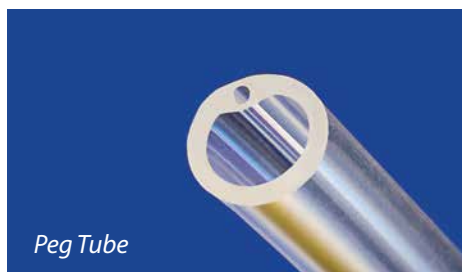

## Jejunostomy Tubes (J thru G)

- Must be placed through either a 16Fr or 20Fr MILA PEG tube.
- Continuous nutritional support via a jejunostomy tube positioned in duodenum or jejunum.
- Sealed Twoomey adapter permits evacuation of stomach from side port and placement of J-tube through top port.
- **Grip tip** on tube for grasping with endoscope.
- **Purple luer locks** to indicate for enteral nutrition only.

For **SURGICALLY PLACED** J-tubes, refer to Nasogastric Feeding Tubes on pages 32-33.

DESCRIPTION	ITEM #
6Fr x 90cm (36in) - Order PEG16 or PGS16	J636
8Fr x 90cm (36in) - Order PEG20 or PGS20	J836
10Fr x 90cm (36in) - Order PEG20 or PGS20	J1036

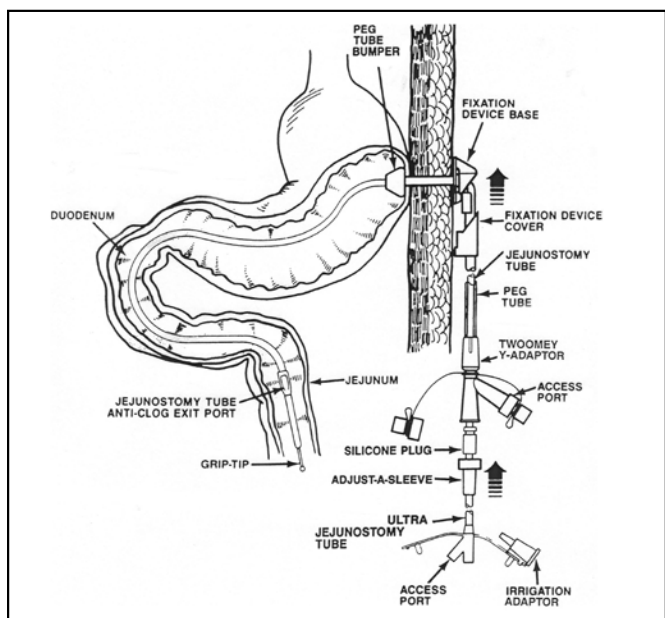
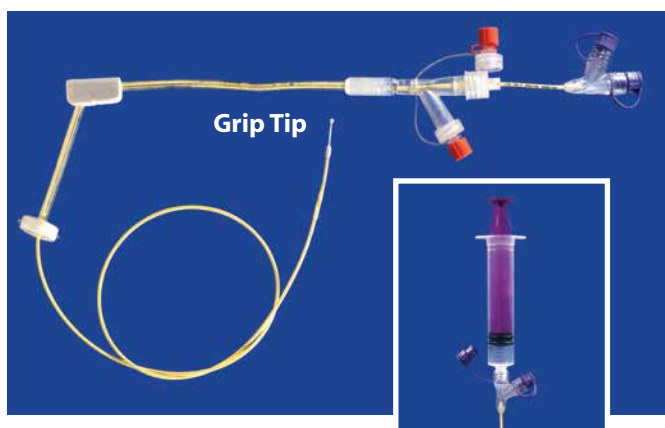

## Mic-Key – Low Profile Gastrostomy Device

- Balloon style cuff which enables insertion and removal without trauma after a stoma is formed.
- Can be easily replaced by the client.
- Kit includes patient care kit with 6cc & 60cc syringes, right angle feeding set, bolus feeding set and care giver guide.
- Available in 12Fr, 14Fr, 16Fr, 18Fr, 20Fr and 24Fr diameters. Lengths from 0.8cm up to 5.0cm, a total of combinations. Length is measured from the proximal side of the balloon to the skin surface. Please refer to our website for a PDF of all sizes or call our office for the complete list of sizes and lengths. Special order item, allow 5 business days for delivery.

DESCRIPTION	ITEM #
Mic-Key - specify Fr size and length	Mic-Key
Stoma Measuring Device	M5555
24in Right Angle Feeding Set - 5 pack	RFS24
Bolus Feeding Set - 5 pack	BFS12



## Cystostomy/Gastrostomy Catheter

- Surgically placed open ended silicone catheter with 20cc balloon, radiopaque stripe, fixation ring, and Y-port. Clamp included.

DESCRIPTION	ITEM #
20Fr x 25cm (10in)	CYGA20
24Fr x 25cm (10in)	CYGA24

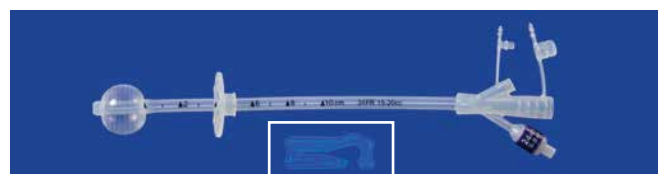

## NG PLUS Feeding Tube with Flushing Stylet

- Use for decompression and feeding.
- Can be left indwelling for days.
- Round, soft atraumatic closed tip with side holes.
- Stylet pre-loaded in every tube and designed to allow **easy wire removal in tight turns**.
- Flushing stylet to facilitate insertion.
- Dual port designed for funnel syringe and luer slip syringe.
- **Superior kink resistance.**
- Non-irritating, LOW FRICTION, clear radiopaque polyurethane with purple stripe, depth markings and suture wing.
- Color coded purple for safety.
- **OTHER USES - oxygen delivery, male canine urine catheter, surgically placed jejunostomy tube** (see sterile items listed below).

DESCRIPTION	ITEM #
5Fr x 55cm (22in) sterile	NGP522S
5Fr x 90cm (36in) sterile	NGP536S
6Fr x 55cm (22in)	NGP622
6Fr x 55cm (22in) sterile	NGP622S
6Fr x 90cm (36in)	NGP636
8Fr x 90cm (36in)	NGP836
8Fr x 90cm (36in) sterile	NGP836S
8Fr x 108cm (43in)	NGP843
8Fr x 140cm (55in)	NGP855
10Fr x 90cm (36in)	NGP1036
10Fr x 90cm (36in) sterile	NGP1036S
10Fr x 140cm (55in)	NGP1055
12Fr x 108cm (43in)	NGP1243

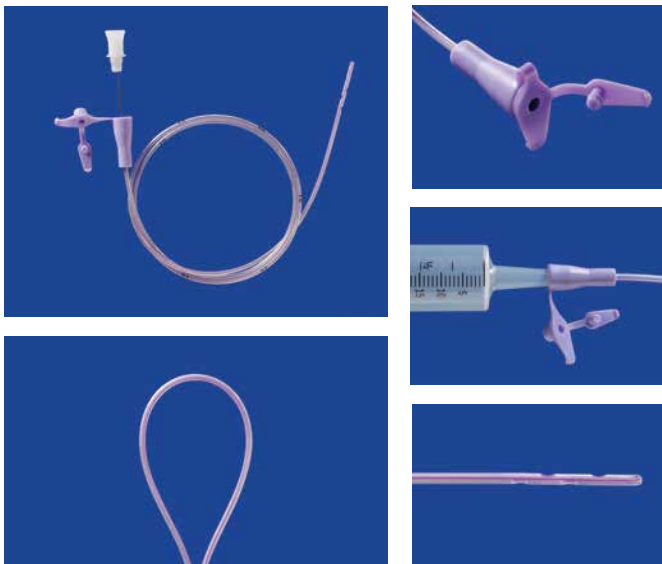

## WEIGHTED NG PLUS Feeding Tube with Flushing Stylet

Weighted NG Plus Feeding tubes have all of the same features as non-weighted tubes. Weight is in the distal tip.

DESCRIPTION	ITEM #
6Fr x 55cm (22in) - 1 Gram weight	NGP622W
8Fr x 108cm (43in) - 3 Gram weight	NGP843W
10Fr x 90cm (36in) - 3 Gram weight	NGP1036W
12Fr x 108cm (43in) - 3 Gram weight	NGP1243W

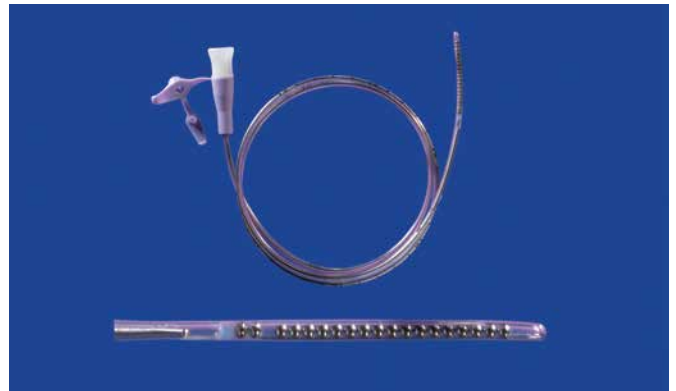

## Feeding Tube Extension

- Color coded purple for safety, to indicate feeding.
- Male luer fits the port of all MILA yellow and purple NG Tubes.
- Total length 150cm/60in.

ITEM #FTE60

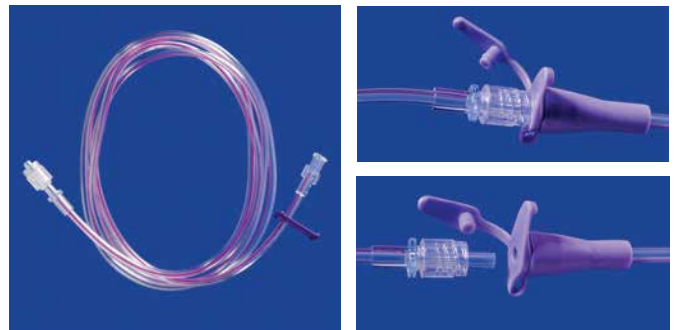



## Nasogastric Feeding Tube with Stylet

- Use for decompression and feeding.
- Can be left indwelling for days.
- Flushing stylet to facilitate insertion.
- Non-irritating radiopaque polyurethane.
- Depth marks.
- Y-adapter for feeding, medication and flushing.
- Suitable for oropharyngeal oxygen delivery.
- Can be used as surgically placed Jejunostomy Tubes.

DESCRIPTION	ITEM #
3Fr x 25cm (10in) sterile	NG310S
5Fr x 55cm (22in) sterile	NG522S
6Fr x 55cm (22in)	NG622
6Fr x 90cm (36in)	NG636
8Fr x 108cm (43in)	NG843
8Fr x 140cm (55in)	NG855
10Fr x 90cm (36in)	NG1036
10Fr x 108cm (43in)	NG1043
10Fr x 140cm (55in)	NG1055
12Fr x 108cm (43in)	NG1243
14Fr x 125cm (50in) Length adjustable and includes suture wing	NG1450
18Fr x 250cm (100in) Length adjustable and includes suture wing	NG18100

See MILA website for link to YouTube video.



## Weighted Nasogastric Feeding Tube with Stylet

- Weight in distal end.
- Depth marks.
- Non-irritating radiopaque polyurethane.
- Use for decompression and feeding.
- Flushing stylet to facilitate insertion.
- Y-adapter for feeding, medication, and flushing.

DESCRIPTION	ITEM #
6Fr x 55cm (22in) - 1 Gram weight	NG622W
8Fr x 108cm (43in) - 3 Gram weight	NG843W-3
8Fr x 108cm (43in) - 7 Gram weight	NG843W-7
10Fr x 90cm (36in) - 3 Gram weight	NG1036W
10Fr x 108cm (43in) - 3 Gram weight	NG1043W
12Fr x 108cm (43in) - 3 Gram weight	NG1243W

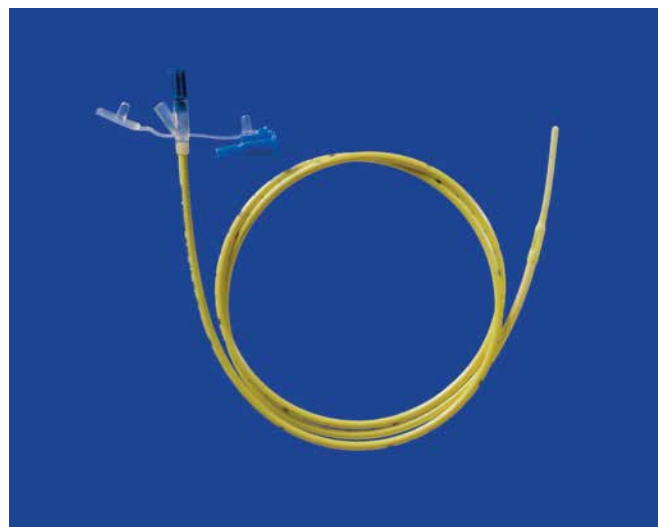

## Esophagostomy Feeding Tubes – Polyurethane

**NEW INFO**

- Place using MILA tunneler (ETUN14 or ETUN18), see page 35, or place in the usual manner.
- Tapered open end with multiple side holes.
- Clear, non-irritating polyurethane material that resists kinking.
- Secure Y-adapter for feeding, medication and flushing.
- Length adjustable **after** placement by cutting the proximal end and replacing Y-adapter.
- Suture wing included (#2580/#2590).
- Radiopaque stripe with depth markings.

DESCRIPTION	ITEM #
10Fr length adjustable up to 75cm (30in) - Use with #ETUN14 for placement.	E1030
14Fr length adjustable up to 33cm(13in)	E1413
14Fr length adjustable up to 75cm (30in) - Order 75cm or 125cm length for use with MILA Tunneler.	E1430
14Fr length adjustable up to 125cm (50in), includes stiffening stylet	E1450
18Fr length adjustable up to 75cm (30in) - Order 75cm or 125cm length for use with MILA Tunneler.	E1830
Y-Replacement Kit	E-Y
14Fr Suture Wing - 10 pack	2580
18Fr Suture Wing - 10 pack	2590



The MILA polyurethane esophagostomy catheter achieves much greater inner diameters with thinner walls, compared to silicone esophagostomy catheters. This results in greater flow rates through a smaller catheter.

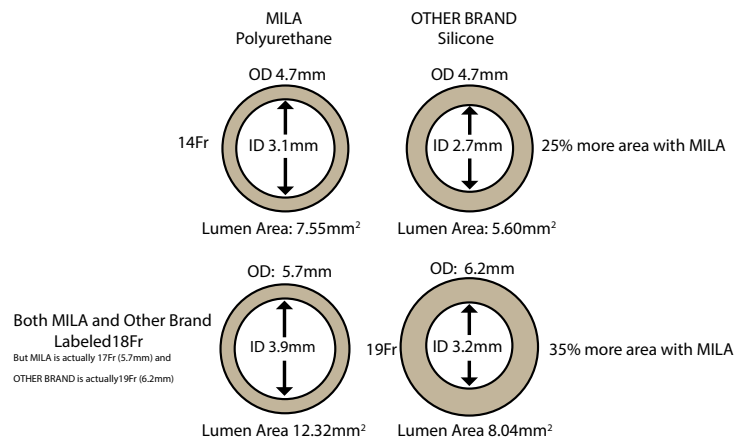
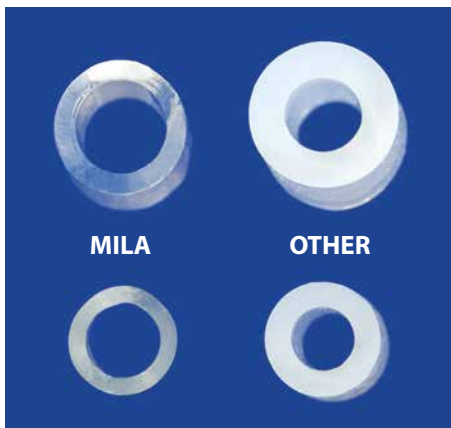

## Tunneler for Esophagostomy Feeding Tube Placement

**EASIER AND FASTER** – Retrograde tunneling greatly improves the ability to easily, safely and quickly position the MILA **length adjustable** Esophagostomy Feeding Tubes. This technique allows the distal tip of the catheter to be manually passed through the mouth into the esophagus. The proximal end of the tube is pulled through the neck with the tunneler. Trim length and replace hub. *See MILA website for link to YouTube video.*

DESCRIPTION	ITEM #
14Fr Esophagostomy Tube Tunneler use for sizes 10Fr and 14Fr tubes	ETUN14
18Fr Esophagostomy Tube Tunneler	ETUN18



★ NEW

## CathCollar™

**For comfortable and secure protection of indwelling esophagostomy catheters.**

- Ultra-Slim, narrow width for maximum patient support and comfort. Less than 1/2 centimeter thick.
- Sizes for cats and dogs for use with esophagostomy tubes, BE tubes, central lines, and to protect glucose monitors.
- Channel allows for quick and easy collar placement around the catheter.
- Elastic mesh storage pocket for proximal end of E-tube when not feeding.
- Durable construction with foam padding.
- Each collar sold with absorbent pads.
- Clinic collar is solid blue color (Item# CCS). CathCollar™ for home is a printed pattern. (Item# CCP)
- Washable and reusable. For best results, ensure hook and loop fasteners are closed before washing.

DESCRIPTION	ITEM #
<b>CLINIC COLLAR - Solid Color</b>	
Neck Size 7 to 10in - Total Length 11in	CCS-XS
Neck Size 9.5 to 12in - Total Length 13in	CCS-S
Neck Size 10.5 to 15in - Total Length 16in	CCS-M
Neck Size 15 to 20in - Total Length 21in	CCS-L
Neck Size 18.5 to 23in - Total Length 24in	CCS-XL
<b>HOME COLLAR - Printed Pattern</b>	
Neck Size 7 to 10in - Total Length 11in	CCP-XS
Neck Size 9.5 to 12in - Total Length 13in	CCP-S
Neck Size 10.5 to 15in - Total Length 16in	CCP-M
Neck Size 15 to 20in - Total Length 21in	CCP-L
Neck Size 18.5 to 23in - Total Length 24in	CCP-XL
<b>Replacement Absorbent Pads - 24 pack</b>	CC-PADS



## Percutaneous Balloon Catheter Kit for Cystostomy and Gastrostomy

- Introduction uses Seldinger wire, followed by peel away sheath.
- **Open ended** silicone catheter with 20cc balloon, depth markings, and radiopaque stripe.
- 20Fr x 25cm (10in) catheter with Y-port and fixation ring.
- **Short catheter tip** design reduces gastric mucosa irritation.
- Large funnel Y-port with locking caps.
- Adjustable fixation ring prevents catheter migration.
- Kit includes catheter, catheter-over-needle introducers, guidewire, peel away sheath with dilator, 12Fr dilator, scalpel, drape, gauze, suture, and syringe.

ITEM #PBC20



## Cat Model

Use to demonstrate the placement of esophagostomy tubes with the MILA Tunneler.

ITEM # CatModel



## Esophagostomy Feeding Tubes – Silicone

- Radiopaque, silicone material.
- Open end with multiple side holes.
- Female luer lock adapter with tethered cap.

DESCRIPTION	ITEM #
12Fr x 38cm (15in) with 5cm of sideholes	SE1215
14Fr x 38cm (15in) with 7cm of sideholes	SE1415
20Fr x 38cm (15in) with 10cm of sideholes	SE2015
20Fr x 55cm (22in) with 10cm of sideholes	SE2022
30Fr x 55cm (22in) with 12cm of sideholes	SE3022



## Esophageal Balloon Dilation Feeding Tube

Use this one-stage esophageal balloon dilation feeding tube for palliative management of benign esophageal stricture and for feeding of cats and dogs. This is an effective, single-procedure alternative to repeated expensive balloon dilations, and incorporates the esophageal feeding tube.

**DESIGN:** The BE-tube has a double balloon surrounding the tube. A compliant outer balloon covers a non-compliant inner balloon for optimal, low profile, long term, routine at home dilation of strictures.

- BE-tube is clear, non-irritating polyurethane ideal for long term use.
- Lateral ports minimize catheter occlusion.
- Radiopaque line for x-ray visualization aids exact placement.
- Latex free.
- **Accessory kit** contains two Hydrophilic Nitinol wires with steerable tip (.035in x 80cm and .035in x 150cm), a Centesis Valve (#175450NB), and a stopcock (#2405).
- **Items needed for placement** and operation of the BE-tube are the accessory kit (#BE-ACC), peel away introducer, and inflation device (#BE-BIG60).

DESCRIPTION	ITEM #
10Fr x 75cm (30in) Feeding Tube with a balloon 10mm diameter x 12cm length - Order with BE14PAI	BE1012
14Fr x 75cm (30in) Feeding Tube with a balloon 15mm diameter x 15cm length - Order with BE14PAI	BE1415
14Fr x 75cm (30in) Feeding Tube with a balloon 20mm diameter x 20cm length - Order with BE14PAI	BE1420
18Fr x 75cm (30in) Feeding Tube with a balloon 25mm diameter x 25cm length - Order with BE18PAI	BE1825
18Fr x 75cm (30in) Feeding Tube with a balloon 30mm diameter x 30cm length - Order with BE18PAI	BE1830

Peel Away Introducer	Required, Select One	
10Fr and 14Fr Tube use 24Fr x 13cm Sheath		BE14PAI
18Fr Tube use 26Fr x 13cm Sheath		BE18PAI

Accessory Kit - Wires, Centesis Valve, Stopcock	Required	BE-ACC

Inflation Device	Required and Reuseable	
60cc Inflation Device		BE-BIG60

**USE:** Once a BES has been diagnosed and traditionally balloon-dilated, the BE-Tube is placed similarly to a standard esophageal feeding tube (E-Tube), with some technical differences. The owner performs twice daily balloon dilations at home, in their unsedated pet, using predetermined air volumes. This tube can also provide supplementation of food, water and medications. While stricture dilation can be uncomfortable in humans, the initial stricture effacement would occur under the initial anesthetic episode, so subsequent dilations would not be expected to be associated with discomfort. In between the daily dilation procedures, the balloon would be self-constrained permitting passage of normal food and liquid boluses. The BE-Tube is typically removed approximately 4-6 weeks later, often under general anesthesia for repeat esophagoscopy to confirm stricture resolutions, it can also be removed in an awake patient.



See MILA website for link to YouTube video.

See 2018 publication: [http://www.milainternational.com/media/wysiwyg/BE\\_Tube\\_Publication\\_2018.pdf](http://www.milainternational.com/media/wysiwyg/BE_Tube_Publication_2018.pdf)

## Guidewire Inserted Chest Tube Procedure Kit

- **Place using local and sedation.**
- Single lumen radiopaque polyurethane catheter with multiple fenestrations.
- Use for pyothorax, hemothorax, pneumothorax, emergency peritoneal lavage and pericardial drain.
- Insertion using the Seldinger catheter-over-guidewire technique.
- Normally closed bi-directional valve with luer adapters prevents air from entering chest.
- Additional suture wing for secure adjustment and attachment.
- **NEW larger 12 French** size with pre-loaded stiffening stylet and skin dilator in the kit.
- Multiple drainage holes.
  - 14Ga fenestrated up to 4cm or 8cm mark.
  - 12Ga fenestrated up to 6cm or 15cm mark.
  - 12Fr fenestrated up to 16cm mark.
- Kit includes introducers, guidewire, dilator, catheter, suture wings, and neutral displacement valve.

DESCRIPTION	ITEM #
14Ga x 20cm (8in) Fenestrated up to 4cm	CT1404
14Ga x 20cm (8in) Fenestrated up to 8cm	CT1410
12Ga x 20cm (8in) Fenestrated up to 6cm	CT1206
12Ga x 30cm (12in) Fenestrated up to 15cm	CT1210
12Fr x 30cm (12in) Fenestrated up to 16cm	CT12Fr16

See MILA website for link to YouTube video.

Photos courtesy of Mike Ethier DVM, DVSc, DACVECC



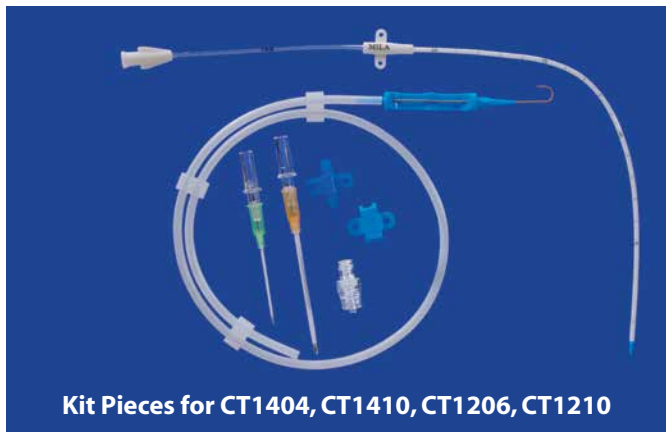

Kit Pieces for CT1404, CT1410, CT1206, CT1210

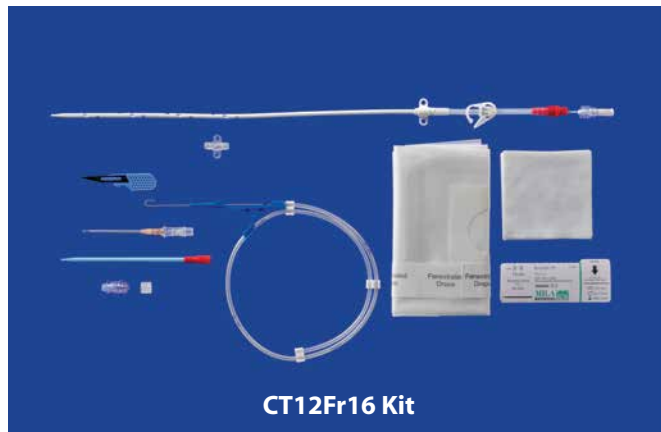

CT12Fr16 Kit



CT12Fr Stiffening Stylet

## Chest Tube Suction Bulb with Luer

- Continuous gentle suction.
- Luer lock adapter for secure attachment to MILA Guidewire Chest Tube.
- Add barbed adapter (Item #2350) for flared chest tube.
- Volume marking provides easy measurement.
- Non-reflux valve.

DESCRIPTION	ITEM #
100cc suction bulb	CG100
150cc suction bulb	CG150
200cc suction bulb	CG200
400cc suction bulb	CG400
Female luer lock adapter accepts 20-40Fr tube Each individually packed and sterile	2350

**(10 pack)**



## Chest Tube with Sharp Trocar and Adapters (Blunt trocar on page 49.)

- **Sizes 10, 12, and 14 include clamp** and barbed adapter.
- **Sizes 16, 20, 24, 28, and 32 include clamp, barbed adapter, and 36 inches (90cm) of sterile bubble tubing.**
- Open-end with two large side holes.
- Depth marks.
- PVC material.

DESCRIPTION	ITEM #
10Fr x 19cm (7.5in)	CTT10S
12Fr x 19cm (7.5in)	CTT12S
14Fr x 19cm (7.5in)	CTT14S
16Fr x 21cm (8in)	CTT16
20Fr x 34cm (13.5in)	CTT20
24Fr x 34cm (13.5in)	CTT24
28Fr x 34cm (13.5in)	CTT28
32Fr x 34cm (13.5in)	CTT32



## Silicone Chest Tubes

- Very kink resistant.
- Radiopaque single lumen open-end with multiple side holes.
- Use for drainage of air or fluid.
- Surgically place or use Kelly clamp.
- Includes clamp, barbed adapter, or stopcock.

DESCRIPTION	ITEM #
12Fr x 38cm (15in) with 5cm of sideholes	CT1215
14Fr x 38cm (15in) with 7cm of sideholes	CT1415
20Fr x 38cm (15in) with 10cm of sideholes	CT2015
20Fr x 55cm (22in) with 10cm of sideholes	CT2022
30Fr x 55cm (22in) with 12cm of sideholes	CT3022

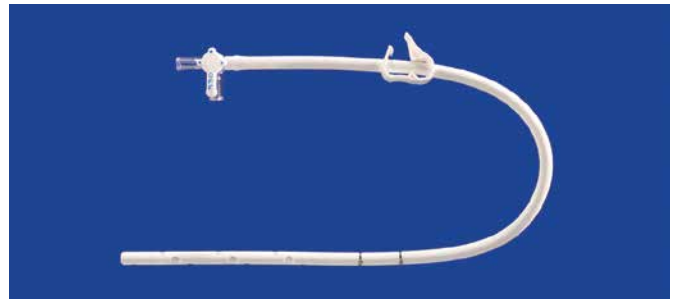

★  
NEW

## Bubble Tubing

Bubble Tubing gets its name from the fact that it has an inconsistent inner and outer diameter (wide and narrow areas every few feet). This makes it versatile, mainly for cutting sections to transition between unequal barbed connectors. For example, connecting a small barbed adapter from a chest drain to a large barbed adapter on a Pluer-Evac suction set. It is very handy to keep a section of Bubble Tubing in the clinic for a variety of unpredictable needs related to stomach tubes, feeding tubes, chest tubes, O<sub>2</sub> delivery, etc.

DESCRIPTION	ITEM #
3 Foot Length, Sterile	BT03
20 Foot Length, Non-sterile	BT20





## Chest Tube Adapter with Stopcock

- The **leak proof** adapter is assembled to include a three-way stopcock, clamp and barbed adapter for 18-34Fr tubes.
- Fits most flare end chest tubes.
- Can be used with a variety of patient tubes such as drains and nasogastric.

DESCRIPTION	ITEM #
16Fr x 17cm (7in)	175420
20Fr x 25cm (10in)	175425



## Suction Connector for Bilateral Chest Tubes

IMPROVED - Longer length. This set connects bilateral chest tubes to a single vacuum source. Luers allow easy disconnect and reconnect. Bubble tubing can be cut to accommodate various underwater seal sets. Works well with items #175420 and #175425 (Chest Tube Adapter with Stopcock.)

DESCRIPTION	ITEM #
20Fr Suction Set	175800

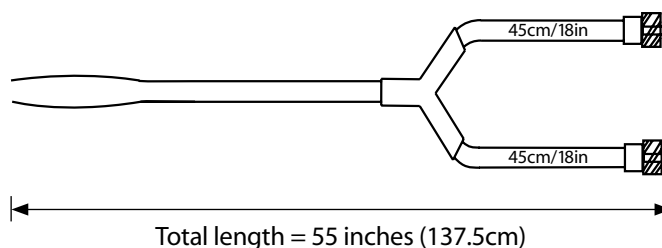

## Chest Tube Adapter for Suction Systems

Securely connect female luer lock or funnel style chest tubes to suction systems from other manufacturers, eg., Pleur-Evac and Thoraseal. Each set contains christmas tree adapters and bubble tubing that can be trimmed to fit the suction device.

DESCRIPTION	ITEM #
Dual Christmas Tree Adapter - includes two dual adapters and bubble tubing with clamp.	175300
Male Luer Lock & Dual Christmas Tree Adapter - includes one luer lock adapter, one dual adapter, and bubble tubing with clamp.	175380

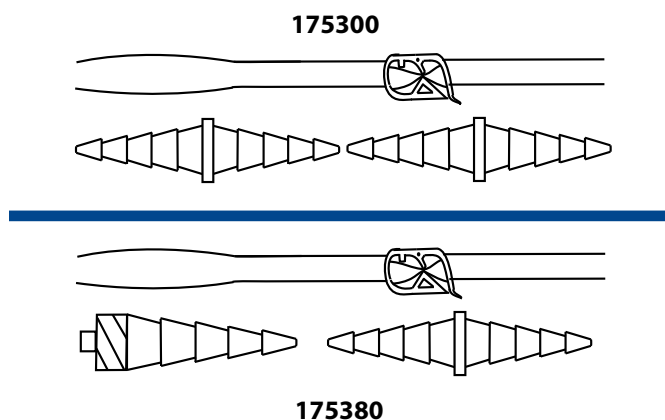

## Centesis Adapter – Automatic 3-Way

**NEW** Drainage Bag Added

- **NEW COLLECTION BAG** - 1000ml, 15in drain line with luer lock, anti-reflux valve and fluid drain port.
- Unique valve allows aspiration and evacuation without disconnecting the syringe, and without turning a stopcock. SAVES TIME AND AVOIDS MISTAKES.
- Use as a chest tube adapter.
- Use for chest tap, belly tap, or anytime you want to remove air or fluid.
- Includes a barbed adapter to fit 18-34Fr flared tubes.

DESCRIPTION	ITEM #
Centesis Adapter with Spin Luer Lock - No Tube	175440
Centesis Adapter with total Length 12.5cm (5in)	175450
Centesis Adapter with total Length 40cm (16in)	175460
Without Collection Bag:	
Centesis Adapter with Spin Luer Lock	175440NB
Centesis Adapter with total Length 12.5cm	175450NB
Centesis Adapter with total Length 40cm	175460NB

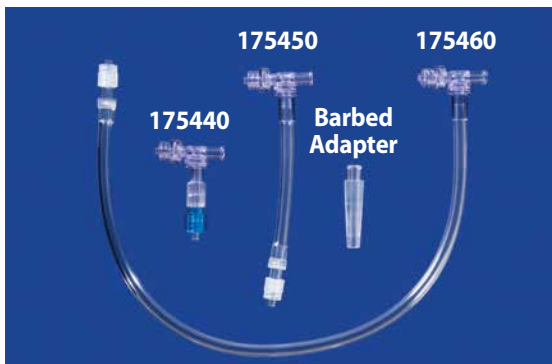

See MILA website for link to YouTube video.

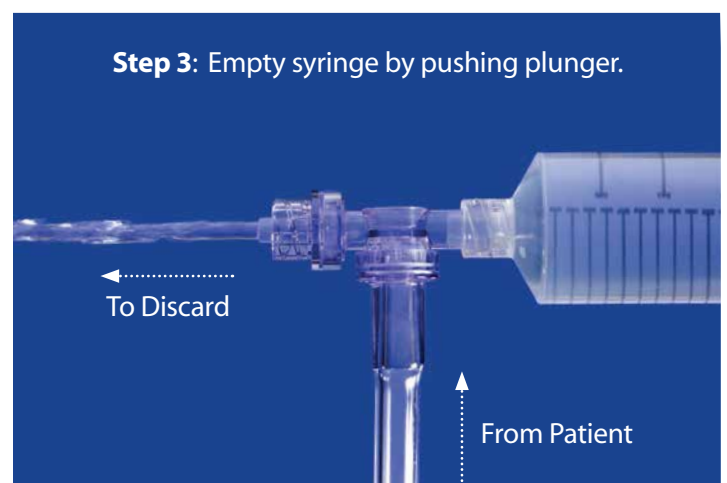
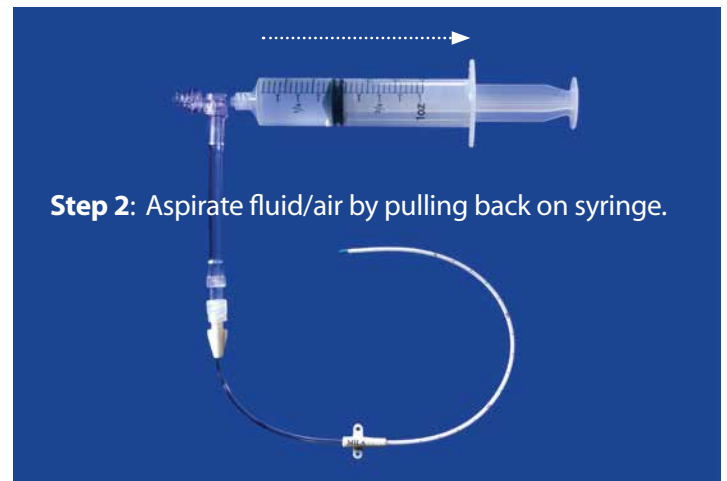
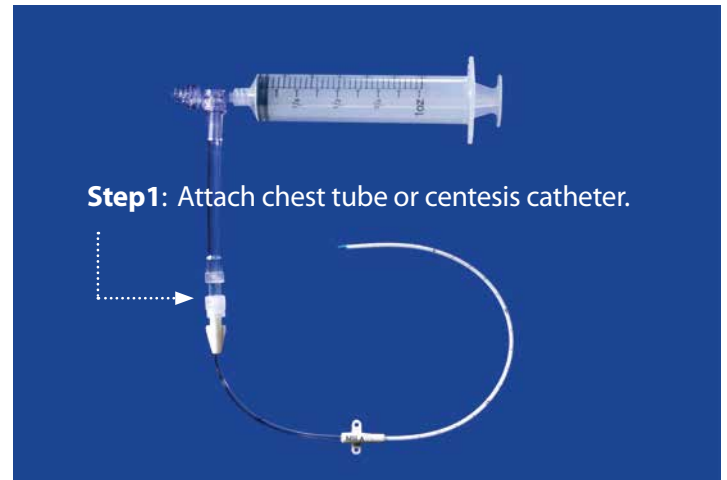

## Heimlich Valve

- One way valve.
- #H2900 is pillow style with male luer lock adapter and christmas tree adapter. Total pillow length is 12cm (5 inches).
- #H5300 is a semi-rigid cylinder style with christmas tree adapters. Total cylinder length is 16cm (6.5 inches).

DESCRIPTION	ITEM #
Pillow style, 5 inches long, 12-30Fr tubes	H2900
Semi-rigid cylinder to fit 20-40Fr tubes	H5300

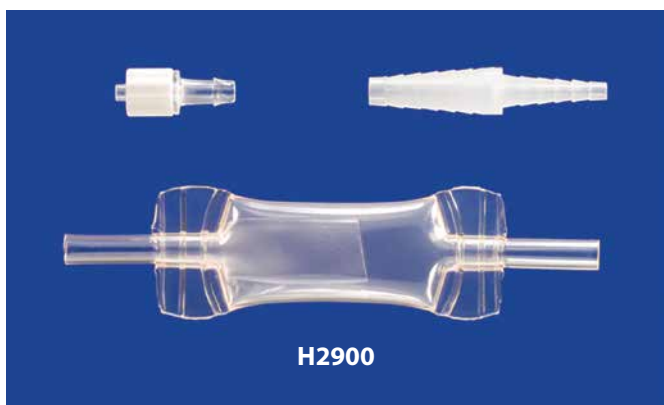

## Flushing Wye Set for Large Chest Tubes

Flush large chest tubes with this large bore (6.35mm ID) wye set.

ITEM #CTF6

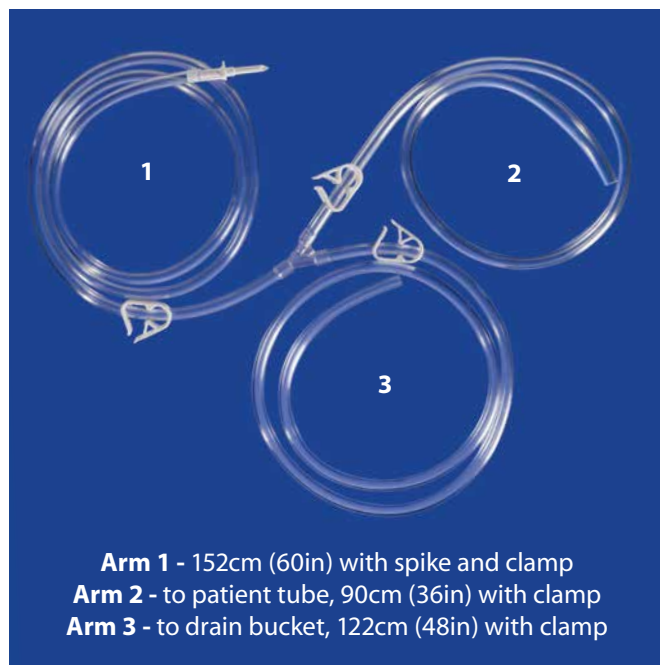

## Fecal Management System

### FOR COLLECTION OF LIQUID STOOL AND ODOR

The Fecal Management System is a 20Fr or 24Fr soft silicone catheter inserted into the rectal vault for collection of liquid stool. It is retained by an air inflated low pressure balloon. The proximal end of the tube attaches to a large bore collection bag.

- 20Fr for small and medium size dogs. Size is selected by approximating the normal formed stool size.
- 24Fr for medium and large size dogs. Size is selected by approximating the normal formed stool size.
- Reduces infection risk to other animals and humans.
- Measures liquid output.
- Greatly reduces clean up time.
- Retains the odor.

DESCRIPTION	ITEM #
20Fr catheter, extension line, 3 collection bags	FM2000
24Fr catheter, extension line, 3 collection bags	FM2400
Replacement Bag	FMRB



## Percutaneous Peritoneal Drain Kit (Peritoneal Dialysis)- Seldinger Placement

- **Recommended to stock both sizes on every Emergency Cart.**
- Use for Peritoneal Dialysis and other emergency drain needs.
- Non-surgical guidewire (Seldinger) introduction.
- Soft, biocompatible polyurethane catheter.
- Radiopaque.
- Kit includes introducer, guidewire, dilator, drain catheter (stiffening stylet in 12Fr), scalpel, drape, suture wing, collection bag with line, sutures, gauze, and drape.

DESCRIPTION	ITEM #
8Fr x 30cm (12in), Fenestrated up to 15cm	PPDK8Fr
12Fr x 30cm (12in), Fenestrated up to 16cm	PPDK12Fr



## Centesis Catheters (Fenestrated)

- Catheter-over-needle style with smooth transition from needle to catheter that aids in placement.
- **Three large skived holes** for maximum drainage and reduction of clogging.
- **Echogenic needle** with bevel indicator for visibility on ultrasound.
- Clear needle hub for flashback confirmation.

DESCRIPTION	ITEM #
4Fr (18Ga) x 7cm (2.75in)	175042
4Fr (18Ga) x 10cm (4in)	175044
5Fr (16Ga) x 7cm (2.75in)	175052
5Fr (16Ga) x 10cm (4in)	175054
5Fr (16Ga) x 15cm (6in)	175056

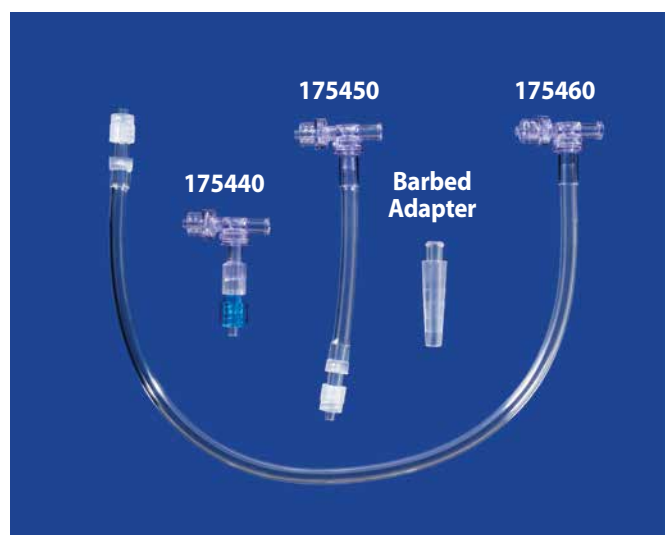
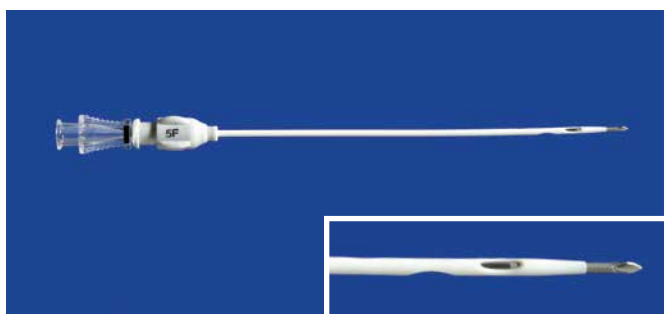

For rapid drainage, see Automatic 3-Way on page 42.

- Catheter-over-needle style with smooth transition from needle to catheter that aids in placement.
- Fenestrated with an additional 4 side holes at the distal end.
- Ideal for tapping pericardial effusion in dogs.

DESCRIPTION	ITEM #
18Ga x 5cm (2.5in)	1802F
18Ga x 9cm (3.5in)	1804F
16Ga x 7.5cm (3in)	1604F
14Ga x 9cm (3.5in)	1404F
14Ga x 13cm (5.25in)	1412F
12Ga x 13cm (5.25in)	1212F

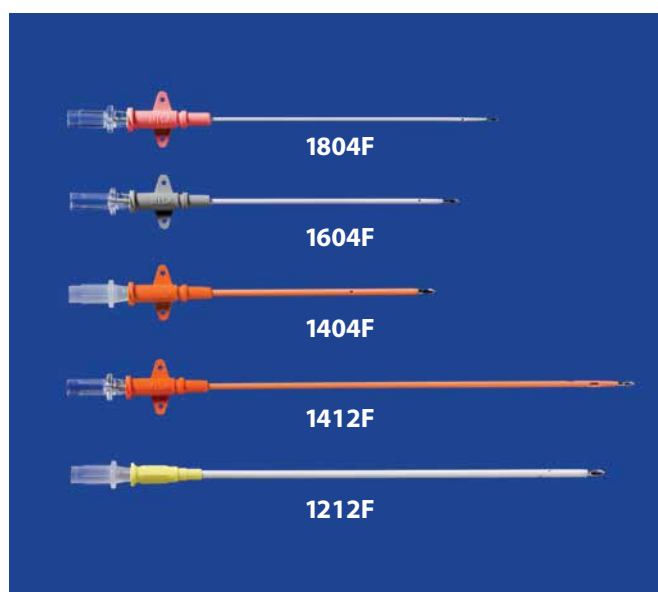

## STIMPOD 450X

- Universal handheld system designed to provide functionality for nerve location, with add-on cables for nerve mapping and neuromuscular blocking agent monitoring. **All cables sold separately.**
- Ability to vary frequency/pitch, pulse width, and current.
- Visual and audible feedback is given when the target current and pulse width ranges are reached indicating probable nerve proximity.
- Displays real time graphical representation of the actual waveform delivered. Pause mode allows changing stimulus parameters without stimulating.
- Non-linear current adjustment. User can pre-program 20 different current and pulse width settings.
- Items needed for basic nerve stimulation are #NB-STIM, #NBMP, and #NBCC.

*See MILA website for information about educational courses.*

### Add-on Cables:

- Nerve Mapping Probe (#NBMP) enables nerve location and transcutaneous nerve mapping at higher currents (to a maximum of 20mA), while the tip offers a contact surface small enough to ensure effective discrimination.
- Tri-axial accelerometer (#NBCA), which provides real time feedback of the strength of contraction of the affected limb (Train of Four, Double Burst, and Post Tetanic Count modes only). The strength of each measured contraction is displayed graphically and the relevant ratios are calculated and displayed.

DESCRIPTION	ITEM #
Stimpod NMS450X Stimulator with Carry Case	NB-STIM
Nerve Location and Mapping Probe Cable	NBMP
NMBA Cable with Accelerometer	NBCA
Crocodile Clip for non-adhesive ground	NBCC



NB-STIM



NBMP



NBCA



NBCC

## Stimulating Needles

Stimulating nerve block needles are for acute pain management and to help increase overall nerve block success. Use with or without ultrasound guidance.

- 2mm pin connector is compatible with MILA Stimpod and most nerve stimulators.
- Insulated needle cannula with a stimulating tip allows for needle guidance using stimulation.
- B Bevel, echo needle tip designed to increase visibility under ultrasound guidance.
- Centimeter markings on the outer cannula to facilitate depth placement.

DESCRIPTION	ITEM #
22Ga x 5cm (2in)	NB2205
21Ga x 8cm (3.1in)	NB2108
21Ga x 10cm (4in)	NB2110

See MILA website for information about educational courses.

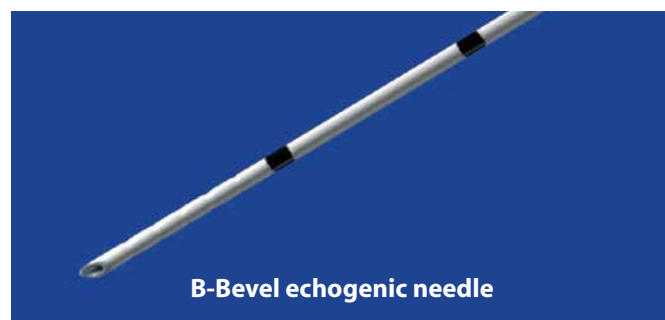
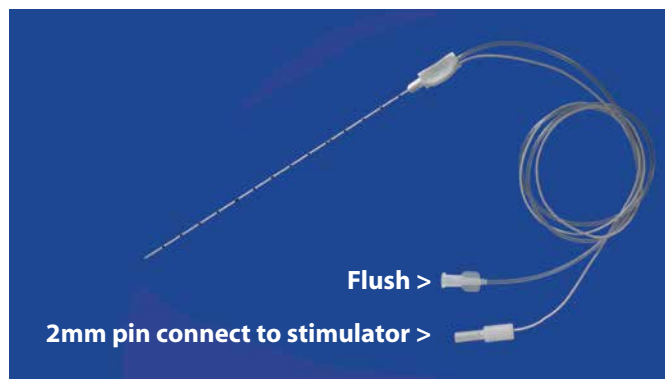

## Echogenic Needles for Ultrasound

**Echogenic needles** feature **360° dimple** reflectors located at the distal end of the needle that create a clear and more defined ultrasound image from any angle without compromising puncture characteristics.

### NERVE BLOCK NEEDLES

- Use for nerve block injections.
- Clear needle tip visualization under ultrasound for safe and accurate needle placement.
- Needle bevel is 30° back cut.

DESCRIPTION	ITEM #
21Ga x 8cm (3.125in)	E2103
21Ga x 10cm (4in)	E2104

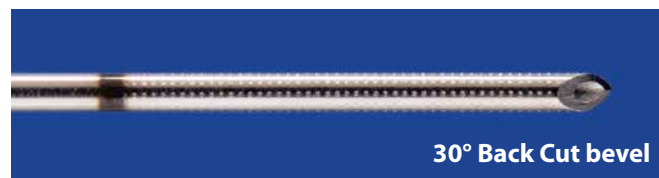

### MSK/SPINAL NEEDLES

- Use for musculoskeletal and spinal injections.
- Clear needle tip visualization under ultrasound for safe and accurate needle placement.
- Needle bevel is Quincke style.

DESCRIPTION	ITEM #
20Ga x 20cm (8in)	E2008
18Ga x 15cm (6in)	E1806
18Ga x 20cm (8in)	E1808

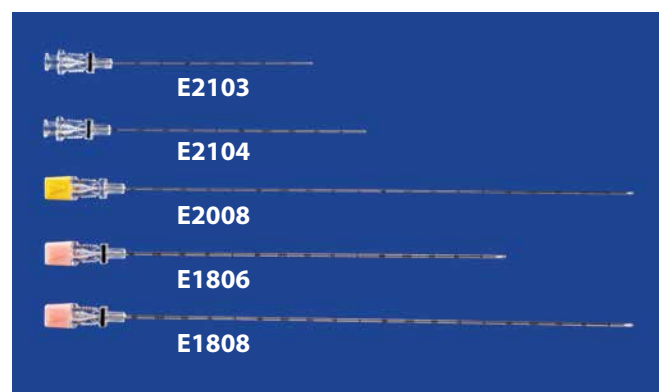

## Jackson Pratt Drain with Trocar

- Silicone radiopaque drain with full perforations.
- Length of drain area = 20cm (8in), overall length 80cm (32in).
- Can trim both ends.

DESCRIPTION	ITEM #
4.5mm with 8Fr (2.7mm) trocar	JP4
7mm with 14Fr (4.7mm) trocar	JP7
10mm with 14Fr (4.7mm) trocar	JP10
13mm with 16Fr (5.3mm) trocar	JP13

Select a suction grenade to complete the CLOSED system.

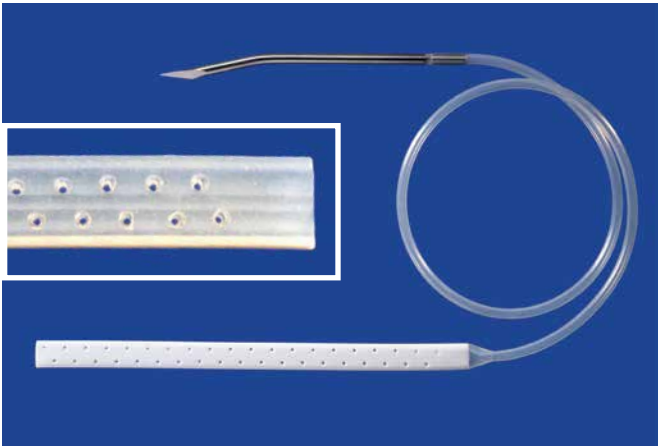

## Blake Drain with Trocar

- Design of drain allows fluid to move through channels. The only suction is at the proximal end of the channels, so OMENTUM DOES NOT STICK.
- Silicone radiopaque fluted drain.
- Length of drain area = 20cm (8in), overall length 80cm (32in).
- Ideal for peritoneal dialysis.
- Can trim both ends.

DESCRIPTION	ITEM #
8mm with 16Fr (5.3mm) trocar	BL8
11mm with 16Fr (5.3mm) trocar	BL11

Select a suction grenade to complete the CLOSED system.

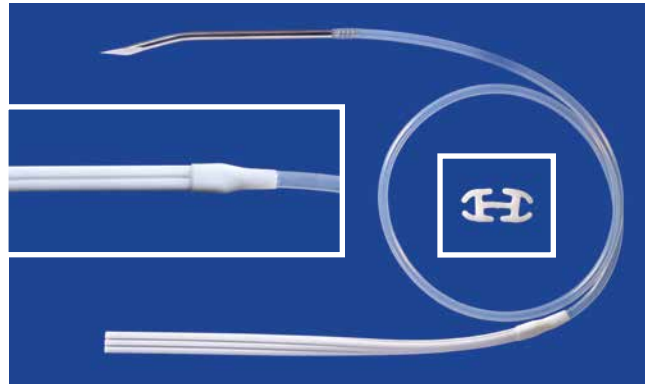

## Grenade – Continuous Suction for Drains

- **Closed system for fluid collection.**
- Attach to all drains - Blake, Jackson Pratt, and Spiral.
- Luer lock cap for secure closure and syringe emptying on the 100, 150, and 200cc. 400cc has a push on cap.
- Low pressure design provides continuous gentle suction and minimizes tissue trauma.
- Volume markings provide easy measurement.
- Non-reflux valve.
- Metal clip for secure attachment.
- Silicone.

DESCRIPTION	ITEM #
100cc suction bulb w/one-way valve	G100
150cc suction bulb w/one-way valve	G150
200cc suction bulb w/one-way valve	G200
400cc suction bulb w/one-way valve	G400





## Spiral Drain with Trocar

- Silicone.
- Radiopaque round spiral fluted drain.
- Spiral design allows greater drainage area.
- Length of spiral area = 30cm (12in), overall length 90cm (36in).
- Can trim both ends.

DESCRIPTION	ITEM #
7Fr (2.7mm) drain with 8Fr (2.7mm) trocar	SP07
10Fr (3.7mm) drain with 11Fr (3.7mm) trocar	SP10
12Fr (4.0mm) drain with 12Fr (4.0mm) trocar	SP12
15Fr (5.0mm) drain with 15Fr (5.0mm) trocar	SP15
19Fr (6.3mm) drain with 15Fr (5.0mm) trocar	SP19

Select a suction grenade to complete the CLOSED system.

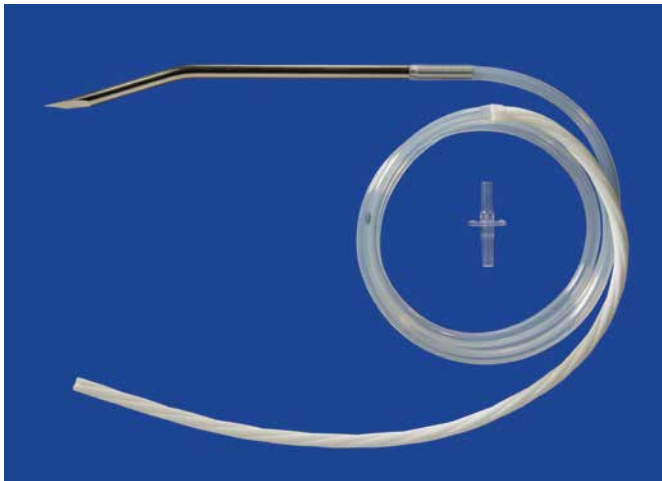

## Abdominal Drain with Blunt Trocar (Sharp trocar on page 40)

- Blunt trocar for safe use in the abdomen.
- Open end with large side holes.
- Depth marks.
- PVC material.

DESCRIPTION	ITEM #
16Fr x 21cm (8in)	DBT16
20Fr x 34cm (13.5in)	DBT20
24Fr x 34cm (13.5in)	DBT24
28Fr x 34cm (13.5in)	DBT28
32Fr x 34cm (13.5in)	DBT32

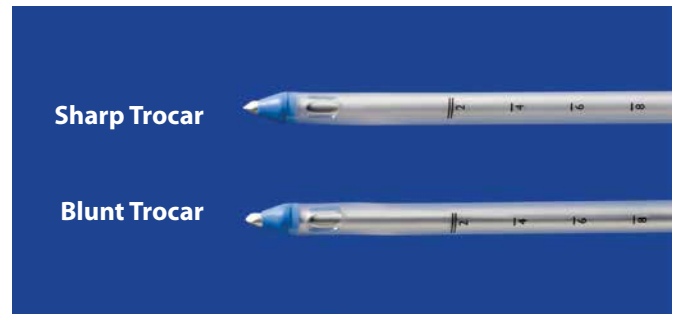

Sharp Trocar Chest Drains on page 40.

## Grenade – Continuous Suction for Drain

- **Closed system for fluid collection.**
- Attach to all drains - Blake, Jackson Pratt, and Spiral.
- Luer lock cap for secure closure and syringe emptying on the 100, 150, and 200cc. 400cc has a push on cap.
- Low pressure design provides continuous gentle suction and minimizes tissue trauma.
- Volume markings provide easy measurement.
- Non-reflux valve.
- Metal clip for secure attachment.
- Silicone.

DESCRIPTION	ITEM #
100cc suction bulb w/one-way valve	G100
150cc suction bulb w/one-way valve	G150
200cc suction bulb w/one-way valve	G200
400cc suction bulb w/one-way valve	G400



## 50ml Bellows Suction System

- 50ml Mini Grenade.
- Supplied with two adapters for connection to all drain sizes.
- Fits Blake, Jackson Pratt, and Spiral Drains.
- Low pressure design provides continuous gentle suction and minimizes tissue trauma.

ITEM #G050

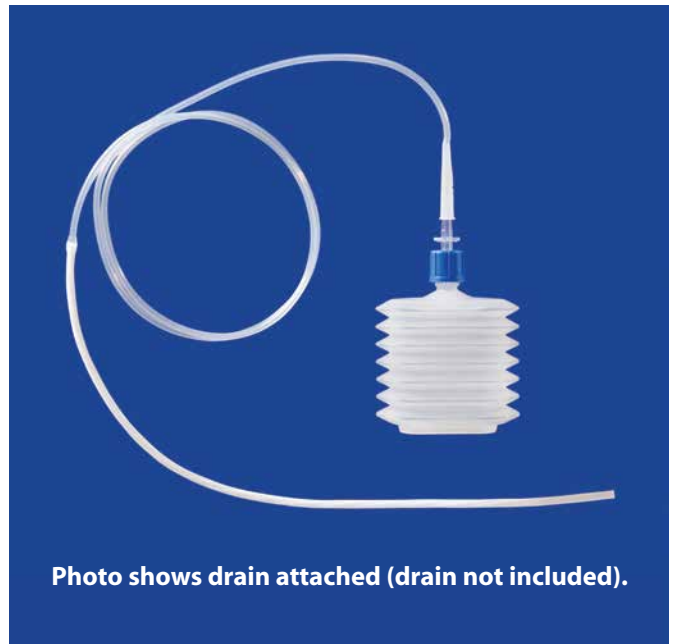

## Pick & Peel Surgical Drape

Use for maintaining a sterile field for catheter placement. Each drape allows the user to select a 3.75cm (1.5in) or 6.9cm (2.75in) fenestration. Drape size 60cm x 60cm (24in x 24in).

- **Adhesive** apertures.
- Sterile, impervious, translucent film.
- Provides superb translucent protection from fluids with optimal drapeability.
- Helps keep patient warm.
- Can be used for small animal DENTAL procedures. Put animal snout through the aperture.

---

ITEM #PPD

---



## Ophthalmic Surgical Drape - Customizable

Use for maintaining a sterile field.

- Size 60cm x 60cm (24in x 24in).
- Rectangle **adhesive** area in center - 12cm (5in) x 15cm (6in).
- NO APERTURE. This allows the surgeon to customize the cut, as needed.
- Superb translucent film, impervious to fluids.
- Optimal drapeability.
- Helps keep patient warm.
- Sterile.

---

ITEM #OSD

---

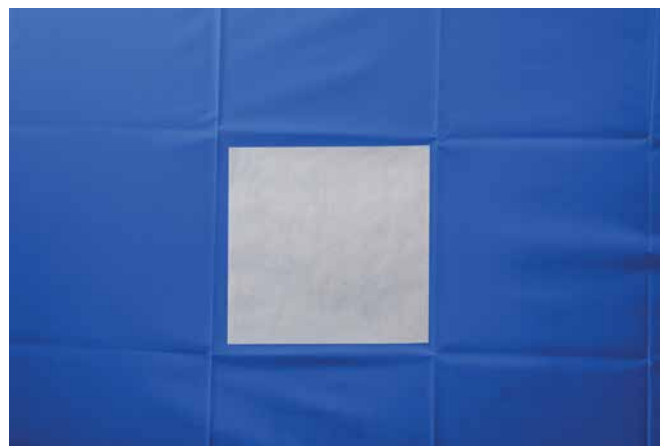

## Equine Castration Drape

Drape size 150cm (60in) x 90cm (36in) clear film with 20cm (8.25in) x 15cm (6in) adhesive fenestration and **edge strips**.

- **Edge strips** make this drape ideal for field use, and many types of procedures.
- **Adhesive** aperture.
- Sterile, impervious translucent film.
- Provides superb translucent protection with optimal drapeability.
- Helps maintain patient temperature.

---

ITEM #ECD

---



## Non-Cuffed

- Silicone Material - MRI Compatible
- Radiopaque
- Reuseable
- Ethylene Oxide Sterilization Recommended

Proximal fitting accepts a 15mm adapter.

DESCRIPTION	ITEM #
1.0mm ID x 9.5cm tube with wire stylet	ETN10
1.5mm ID x 10cm tube with wire stylet	ETN15



## Cuffed

- Silicone Material - MRI Compatible
- Reuseable
- Ethylene Oxide Sterilization Recommended
- Low Pressure, High Volume Cuff

DESCRIPTION	ITEM #
2mm ID, 4.0mm OD - 12Fr x 14cm (5.5in)	ETC20

### FOAL SIZES

10mm ID, 14mm OD - 42Fr x 55cm (22in)	ETC1055
11mm ID, 15mm OD - 45Fr x 55cm (22in)	ETC1155

See MILA website for link to YouTube video.



## Low Dead Space Endotracheal Tube Adapter

- 15mm connector with luer lock sampling side port to replace standard 15mm adapter on endotracheal tubes.
- Low dead space design decreases the mechanical dead space and subsequent CO<sup>2</sup> rebreathing.
- Allows for administration of medications and surfactants as well as monitoring of pressure and gas.

DESCRIPTION	ITEM #
2.0mm ID	ETA20
2.5mm ID	ETA25
3.0mm ID	ETA30
4.0mm ID	ETA40
5.0mm ID	ETA50
6.0mm ID	ETA60
7.0mm ID	ETA70
7.5mm ID	ETA75
8.0mm ID	ETA80
9.0mm ID	ETA90



## Reinforced Endotracheal Tubes with Malleable Stylet

- Wire reinforcement incorporated into the wall of the tube provides safe, **NON-KINKING** airway regardless of patient position.
- Constructed of medical grade, non-toxic PVC material allowing for thinner walls.
- **Malleable stylet included** for increased rigidity and variable shape.
- Latex free.
- High volume, low pressure cuff.
- Radiopaque.
- Fully transparent.
- Atraumatic bevel tip with lateral Murphy eye.
- 15mm connector included.

DESCRIPTION	ITEM #
2.5mm ID, 4.5mm OD - 13Fr x 19.5cm (7.6in)	ETC25R
3.0mm ID, 5.0mm OD - 15Fr x 20.5cm (8.1in)	ETC30R
3.5mm ID, 5.7mm OD - 17Fr x 22cm (8.7in)	ETC35R
4mm ID, 6.1mm OD - 18Fr x 23.5cm (9.3in)	ETC40R
4.5mm ID, 6.7mm OD - 20Fr x 24.5cm (9.6in)	ETC45R
5mm ID, 7.4mm OD - 22Fr x 26cm (10.2in)	ETC50R
5.5mm ID, 7.9mm OD - 24Fr x 27.5cm (10.8in)	ETC55R
6mm ID, 8.5mm OD - 25Fr x 30cm (11.8in)	ETC60R
6.5mm ID, 9.1mm OD - 27Fr x 31cm (12.2in)	ETC65R
7mm ID, 9.5mm OD - 28Fr x 32cm (12.6in)	ETC70R
7.5mm ID, 10.2mm OD - 31Fr x 36cm (14.2in)	ETC75R
8mm ID, 11mm OD - 33Fr x 36cm (14.2in)	ETC80R
8.5mm ID, 11.7mm OD - 35Fr x 36cm (14.2in)	ETC85R
9mm ID, 12.3mm OD - 37Fr x 36cm (14.2in)	ETC90R
9.5mm ID, 13mm OD - 39Fr x 36cm (14.2in)	ETC95R
10mm ID, 13.7mm OD - 41Fr x 36cm (14.2in)	ETC100R

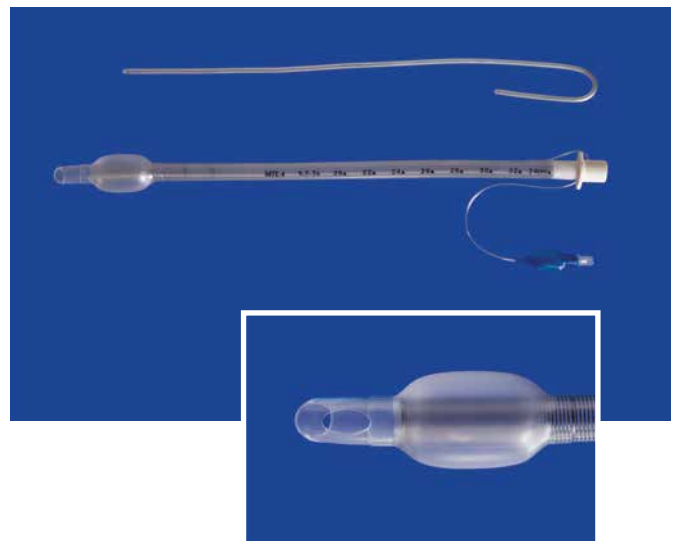

## Airway/ET Tube Exchange Catheter

- Intended for uncomplicated atraumatic endotracheal tube exchange.
- Useful for oxygenating during fluoroscopy.
- 15mm adapter for temporary oxygen delivery, NOT for ventilating the patient.
- 15mm adapter is removed to slide ET tubes out and in.
- Centimeter markings for alignment with endotracheal tube markings.
- Polished atraumatic, open ended catheter with side holes.

DESCRIPTION	ITEM #
8Fr x 80cm (32in)	ETE0880
10Fr x 80cm (32in)	ETE1080
10Fr x 150cm (60in)	ETE10150
15Fr x 80cm (32in)	ETE1580

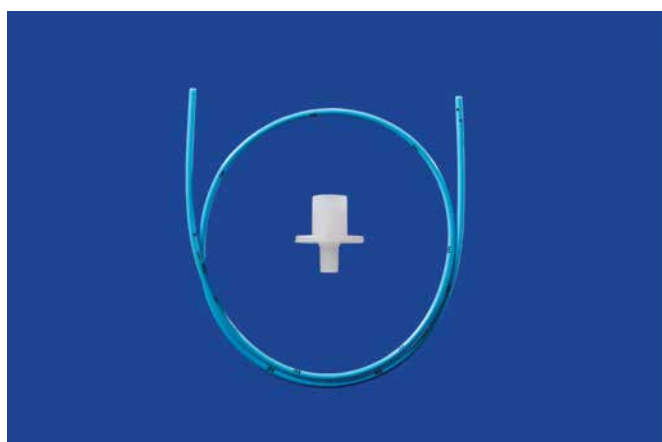
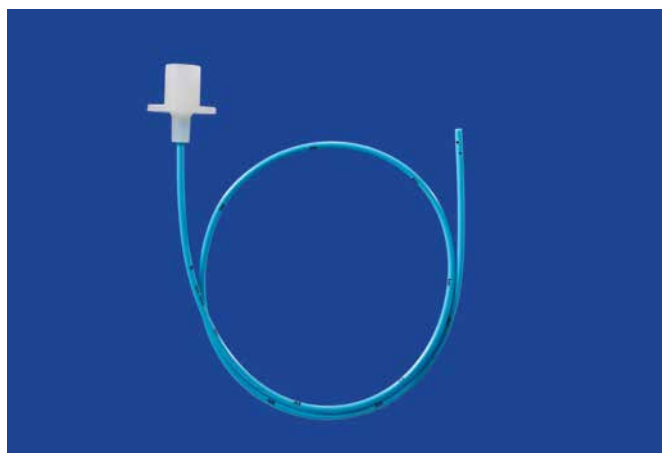

## Atomizer / Throat Sprayer

Deliver topical anesthetic to the nose, throat, hypo pharynx, vocal cords, larynx, and trachea prior to airway manipulation such as intubation, endoscopy, rhinoscopy, and soft palate exam. The benefit is a reduced gag and sensation, reducing pulse, and blood pressure response to intubation.

- Atomize medication into a fine mist of particles 50-80 microns.
- 15Fr (4.7mm) tip x 6.5 inch (15cm) malleable, conformable tube for targeted deposition of medication.
- 5cc syringe is recommended for accurate dosing and proper pressure.
- Priming volume is 0.2ml.
- Use a 3ml syringe for a minimum forecast distance of 100mm upon exiting the sprayer tip, under 25Kpa pressure, to form an area of diameter of no less than 70mm.

ITEM #5380



*"The device makes endoscopy work within the nasal cavity, soft palate, larynx and pharynx much easier by distributing a fine mist of lidocaine or lidocaine/phenylephrine."*

*"We also use the device to distribute same mixture in hard to reach surgical areas such as otic canals, wound flaps, urogenital tracts, and to atomize topical local anesthetics and hemostatic agents to bleeding tumors and derm biopsy sites."*

Andrea Looney, DVM, DACVAA, DACVSMR  
Anesthesia Services, IVG Hospitals, Woburn, MA

**Cuffed**

- Low Pressure Cuff
- Strap

DESCRIPTION	ITEM #
3.5mm ID x 4.8mm OD - Length 40mm	TTC35
4.0mm ID x 5.4mm OD - Length 41mm	TTC40
4.5mm ID x 6.1mm OD - Length 42mm	TTC45
5.0mm ID x 6.7mm OD - Length 44mm	TTC50
5.5mm ID x 7.4mm OD - Length 46mm	TTC55

**Cuffed**

- Obturator
- Low Pressure Cuff
- Strap

DESCRIPTION	ITEM #
6.0mm ID x 8mm OD - Length 53mm	TTC60
6.5mm ID x 8.7mm OD - Length 55.5mm	TTC65
7.0mm ID x 9.4mm OD - Length 64.5mm	TTC70
7.5mm ID x 10.1mm OD - Length 70.5mm	TTC75
8.0mm ID x 10.8mm OD - Length 74.5mm	TTC80
8.5mm ID x 11.5mm OD - Length 77.5mm	TTC85
9.0mm ID x 12.2mm OD - Length 87mm	TTC90
9.5mm ID x 12.9mm OD - Length 90.5mm	TTC95
10.0mm ID x 13.6mm OD - Length 93mm	TTC100

**Cuffed with Obturator, and Inner Cannula**

- Obturator.
- TWO Inner Cannulas with 15mm Connector - Can be switched out for cleaning, and therefore safer practice.
- Cap, Brush, and Strap.

DESCRIPTION	ITEM #
5mm ID x 8.6mm OD - Length 66mm	TTCIC50
Additional Cannula - 5mm ID - with 15mm connector	IC50
6mm ID x 9.2mm OD - Length 71mm	TTCIC60
Additional Cannula - 6mm ID - with 15mm connector	IC60
7mm ID x 10.4mm OD - Length 73mm	TTCIC70
Additional Cannula - 7mm ID - with 15mm connector	IC70
8mm ID x 11.4mm OD - Length 76mm	TTCIC80
Additional Cannula - 8mm ID - with 15mm connector	IC80

**For Non-Cuffed with inner cannula, leave cuff deflated.**

**Non-Cuffed with 15mm Spinning Connector**

DESCRIPTION	ITEM #
2.5mm ID x 3.4mm OD - Length 38mm	TTNC25
3.0mm ID x 4.1mm OD - Length 39mm	TTNC30
3.5mm ID x 4.8mm OD - Length 40mm	TTNC35
4.0mm ID x 5.4mm OD - Length 41mm	TTNC40
4.5mm ID x 6.1mm OD - Length 42mm	TTNC45
5.0mm ID x 6.7mm OD - Length 44mm	TTNC50
5.5mm ID x 7.4mm OD - Length 46mm	TTNC55



## Epidural Pain Management Kit

- Epidural catheter with wire stylet.
- 20Ga is 90cm/36in, 24Ga is 25cm/10in.
- Closed end with side holes.
- Cut to desired length - catheter will not crush.
- Kit includes catheter with wire stylet, tuohy introducer needle, loss of resistance syringe, 0.2 micron bacteria filter, luer lock catheter clamp, suture wing, blade, drape, and tape measure.

DESCRIPTION	ITEM #
24Ga catheter - 20Ga x 4.5cm (1.75in) tuohy needle	9243
20Ga catheter - 18Ga x 7.5cm (3in) tuohy needle	9203
20Ga catheter - 18Ga x 15cm (6in) tuohy needle	9206

See MILA website for link to YouTube video.



## Diffusion Catheter/Soft Tissue Incision Catheter

- 16Ga x 30cm (12in) radiopaque polyurethane catheter with micro ports in the distal end to evenly disperse fluid over 2 inches, 4 inches, 6 inches, 7.5 inches or 9 inches.
- For delivery of pain medication or antibiotics directly to a surgical incision.
- Surgically place in the deepest layer of closure, or by using a 5Fr (#4205 or 4205.5) peel away introducer for wounds.
- Use with MILA administration pump (see page 52), a syringe, or IV pump for continuous infusion.

DESCRIPTION	ITEM #
2in (5cm) Dispersion Area Catheter length = 11cm (4.5in)	DIFF2
4in (10cm) Dispersion Area	DIFF4
6in (15cm) Dispersion Area	DIFF6
7.5in (18cm) Dispersion Area	DIFF7
9in (22.5cm) Dispersion Area	DIFF9
.2 Micron Filter (10 pack) Individually packed / sterile	2420

See MILA website for sample protocols and dosages by Emily McCobb DVM MS DACVA.



Photo courtesy of William Muir DVM, PhD, The Ohio State University

Opioid free soft tissue pain management.

## Stimpod 450X

Universal handheld system designed to provide functionality for nerve location, with add-on cables for nerve mapping and neuromuscular blocking agent monitoring.

See page 46 for details.



## Closed Medication System

PROTECT VETERINARY HEALTHCARE PERSONNEL

Simple and Economical. The MILA CHEMO Safety System is designed to fully protect veterinary healthcare personnel from exposure to hazardous drugs. The systems allow for safe handling of hazardous injectable drugs while optimizing safety, simplicity and the cost of care. The use of a closed system transfer device in conjunction with other safety precautions is a proven way to increase safety levels when preparing, transporting, administering, and disposing of hazardous drugs.

### Closed Male Luer Valve

- Needle free luer locks to any luer syringe to control exposure during drug transport.
- Drip free disconnection.
- Passive safety system that locks and closes the fluid path upon disconnection.
- Simple **permanent** locking feature prevents disconnection and reduces exposure.
- 0.06ml priming volume.
- Single Use.
- Item #12-007, each



### Accessories

#### EZ Fill - Syringe to Syringe Transfer Device

Item #12-006, each



#### Closed Valve Three-Way Stopcock

Item #12-055, each



### Closed Female Luer Valve

- Needle free female luer connects onto any needle or catheter. Designed to reduce exposure after drug infusion.
- Drip free disconnection.
- 0.06ml priming volume.
- Single Use.
- Item #12-004, \$ each



#### Administration Sets

- Universal spike, 224cm (88in) tubing, roller clamp, slide clamp, one injection site located **11 inches** above distal end, spin connector. Priming volume = 25.6ml, 10 drops/ml. Item #175250, each
- Universal spike, 261cm (103in) tubing, roller clamp, slide clamp, **two injection sites located 9 inches and 87 inches** above distal end, spin connector. Priming volume = 28ml, 10 drops/ml. Item #175255, each

### Infusion Access Device Spike with Closed Female Luer

- Use with standard IV bags, glass bottles, and other rigid containers.
- IV spike with closed female luer for adding chemo drugs to bag or bottle.
- Drip free disconnection.
- Single Use.
- Item #12-008, each





## Closed Medication System

PROTECT VETERINARY HEALTHCARE PERSONNEL

### Closed Vial Access Adapter

**NEW DESIGN**

- **100% protection** against aerosols and vapors.
- Drip free.
- **Mechanically and microbiologically closed** with no coring needles.
- More durable closed expansion chamber for collection of drug vapors.
- No need to prime valve with non-filtered air.
- Multi-use, vapor free with drip free connector.
- 0.2 micron bacteria filter for atmospheric air going into the closed system.
- Non-coring plastic spike with **pressure equalization** 0.2 micron one-way filter.
- **New spike design** results in lower attachment force when connecting to the vial and creates a permanent locking feature that prevents disconnection of the vial adapter from the vial.
- 0.10ml priming volume.
- 13mm = Item #12-009, \$4.75 each | 20mm = Item #12-010, each



*Next generation product is yellow to indicate hazardous drugs combined with pending advanced efficacy claims in accordance to USP800.*

### Closed Vial Access Adapter – 13mm

- 13mm
- **Low residual.**
- Item #12-100

See MILA website for link to YouTube video.



DESCRIPTION	ITEM #
Closed Male Luer Valve	12-007
Closed Female Luer Valve	12-004
13mm Closed Vial Access Adapter	12-009
20mm Closed Vial Access Adapter	12-010
EZ Fill - Syringe to Syringe Transfer Device	12-006
Infusion Access Device Spike	12-008
Closed Valve Three-Way Stopcock	12-055
13mm Closed Vial Adapter - Low Residual	12-100
IV Administration Set with One Injection Site	175250
IV Administration Set with Two Injection Sites	175255

## Spinal Needles

Spinal needles with marked and notched hub for easy tip orientation.

DESCRIPTION	ITEM #
22Ga x 15cm (6in)	2206
20Ga x 20cm (8in)	2008
19Ga x 8.75cm (3.5in)	1903
18Ga x 15cm (6in)	1806
18Ga x 20cm (8in)	1808
18Ga x 25cm (10in)	1810
15Ga x 25cm (10in)	1510

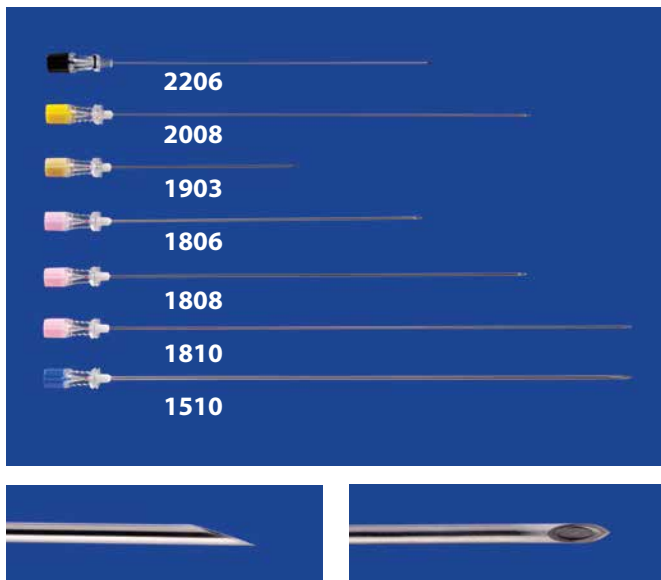

**Echogenic Stimulating Needles for use with nerve stimulator on page 46.**

DESCRIPTION	ITEM #
22Ga x 5cm (2in)	NB2205
21Ga x 8cm (3.1in)	NB2108
21Ga x 10cm (4in)	NB2110

## Tuohy Needles

Tuohy needles with marked and notched hub for easy tip orientation.

DESCRIPTION	ITEM #
22Ga x 4cm (1.5in)	T2215
22Ga x 6.25cm (2.5in)	T2225
22Ga x 8.75cm (3.5in)	T2235
20Ga x 4.75cm (1.75in)	T2018
20Ga x 6.25cm (2.5in)	T2025
20Ga x 8.75cm (3.5in)	T2035
18Ga x 8.75cm (3.5in)	T1803
18Ga x 15cm (6in)	T1806

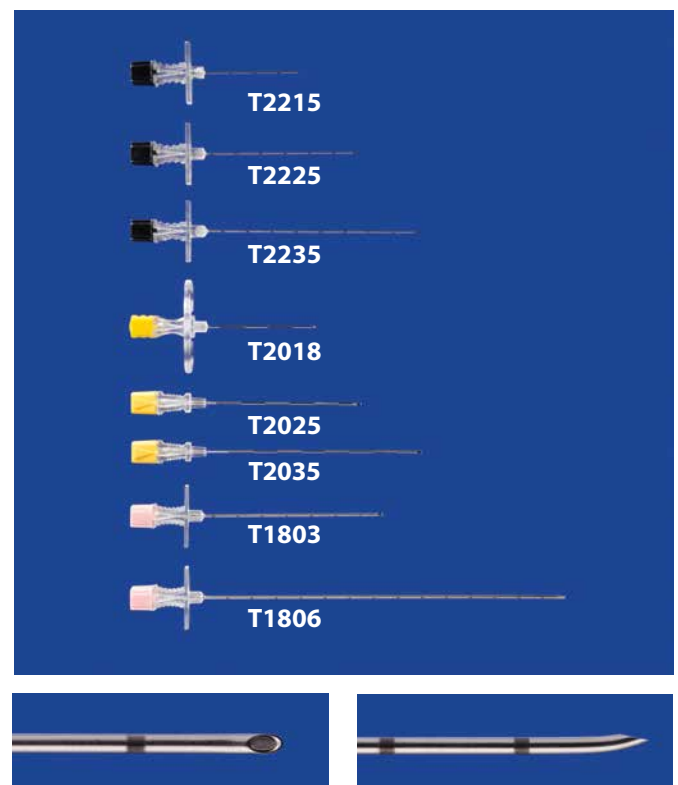

## Echogenic Needles for Ultrasound

**Echogenic needles** feature 360° dimple reflectors located at the distal end of the needle that create a clear and more defined ultrasound image from any angle without compromising puncture characteristics.

### NERVE BLOCK NEEDLES

- Use for nerve block injections.
- Clear needle tip visualization under ultrasound for safe and accurate needle placement.
- Needle bevel is 30° back cut.

DESCRIPTION	ITEM #
21Ga x 8cm (3.125in)	E2103
21Ga x 10cm (4.0in)	E2104



### MSK/SPINAL NEEDLES

- Use for musculoskeletal and spinal injections.
- Clear needle tip visualization under ultrasound for safe and accurate needle placement.
- Needle bevel is Quincke style.

DESCRIPTION	ITEM #
20Ga x 20cm (8in)	E2008
18Ga x 15cm (6in)	E1806
18Ga x 20cm (8in)	E1808



## Olive Tip Needles

### LACRIMAL LAVAGE NEEDLE

- Used to flush and lavage eyes and the lacrimal duct.
- Stainless steel needle with small atraumatic olive tip.
- Female luer designed to fit any syringe.

DESCRIPTION	ITEM #
30Ga x 2.5cm (1.0in)	OT3025
23Ga x 2.0cm (0.75in) Stepped	OT2320
23Ga x 2.0cm (0.75in) Curved	OTC2320
23Ga x 3.0cm (1.25in)	OT2330
23Ga x 3.0cm (1.25in) Curved/Stepped	OTC2330

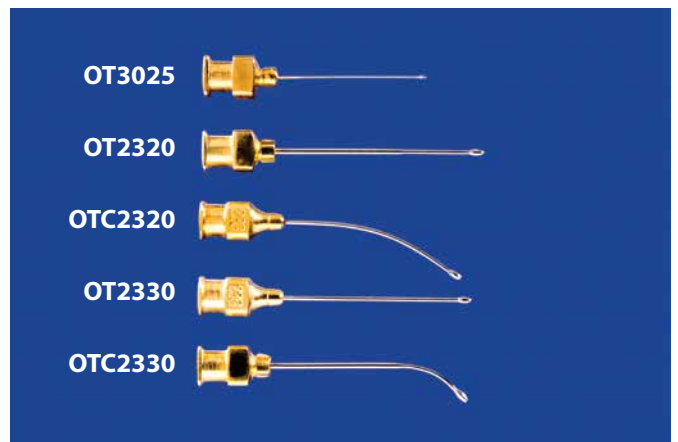

### URINARY & ANAL GLAND LAVAGE NEEDLE

- Used to flush and lavage distal end of feline penis and anal gland.
- Stainless steel needle with small atraumatic olive tip.
- Female luer designed to fit any syringe.

DESCRIPTION	ITEM #
21Ga x 1.3cm (0.5in)	OT2113
21Ga x 2.5cm (1.0in)	OT2125
21Ga x 4.0cm (1.5in)	OT2140

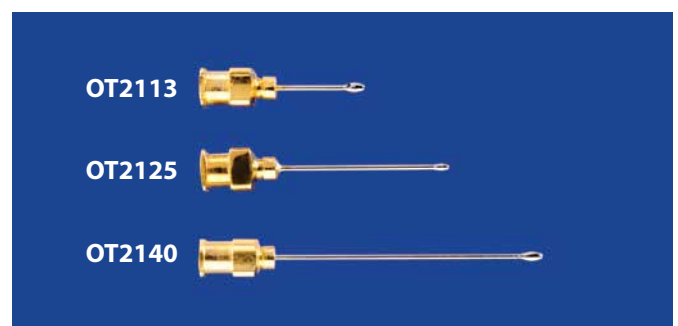

## Eye Lavage Kit/SPL

- For upper or lower lid.
- Single stick insertion method.
- Soft non-irritating disk and tubing.
- Allows application of eye medication away from the site.
- Easily used in clinical and farm setting.
- Kit includes 12Ga straight or 10° angled trocar, catheter, eyelid lifter, extension tube, luer lock adapter, tongue depressor, catheter for medication infusion, and needle free port.
- Repair kit (#6615) includes tubing 20in long, cannula for connecting tubes, 20Ga catheter, tongue depressor, and needle free port.
- Use the elastomeric administration pump for continuous infusion.

DESCRIPTION	ITEM #
Subpalpebral Eye Lavage Kit 60in catheter	6612
Subpalpebral Eye Lavage Kit Angled 10° trocar, 60in catheter	6613
Repair Kit	6615

For Ophthalmic Surgical Drape (#OSD \$3.50), see page 51.

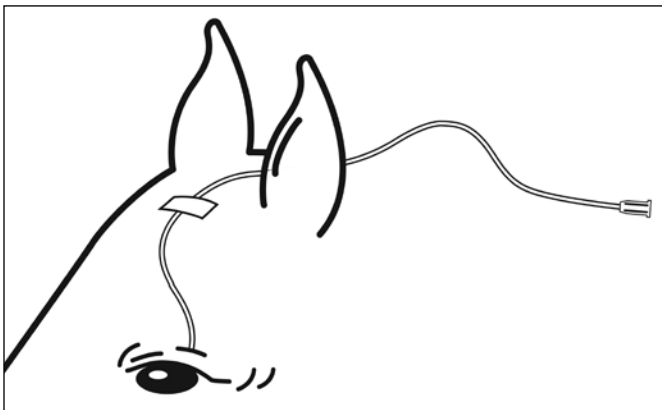

## Elastomeric Pump

- Four layers of latex for sturdiness.
- Recoil of balloon pushes fluid through tubing.
- 100ml fluid reservoir.
- Two flow control tubes are included. FCT12 (0.8ml/hr) is attached to pump. The FCT4 (2.5ml/hr) is included in the package.
- Accuracy rate +/- 15%.

DESCRIPTION	ITEM #
Elastomeric Pump	7100
10ml in 4 hours – 2.5ml/hour	FCT4
10ml in 12 hours – 0.8ml/hour	FCT12
.2 micron filter (10 pack)	2420



## Olive Tip Needles

### LACRIMAL LAVAGE NEEDLE

- Used to flush and lavage eyes and the lacrimal duct.
- Stainless steel needle with small atraumatic olive tip.
- Female luer designed to fit any syringe.

DESCRIPTION	ITEM #
30Ga x 2.5cm (1.0in)	OT3025
23Ga x 2.0cm (0.75in) Stepped	OT2320
23Ga x 2.0cm (0.75in) Curved	OTC2320
23Ga x 3.0cm (1.25in)	OT2330
23Ga x 3.0cm (1.25in) Curved/Stepped	OTC2330

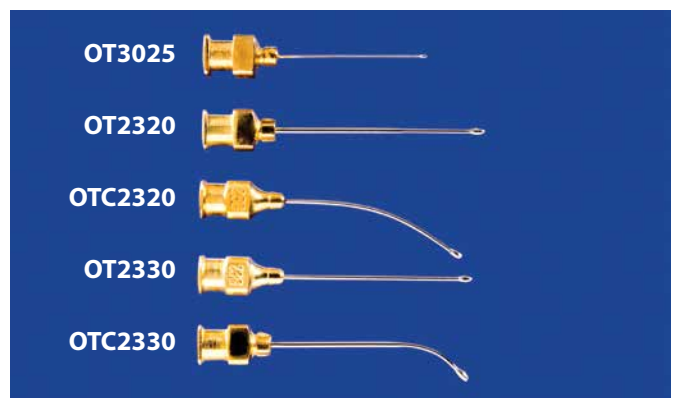

## Uterine Flush

### EMBRYO TRANSFER CATHETER

- Open end silicone catheter.
- Soft balloon cuff ideal for embryo transfer.
- Y-adapter tube assembly includes line to fluid source, drain line and graduated adapter line to catheter.
- Reuseable.

DESCRIPTION	ITEM #
36Fr x 80cm (32in) catheter with 100cc balloon cuff	UFC3680

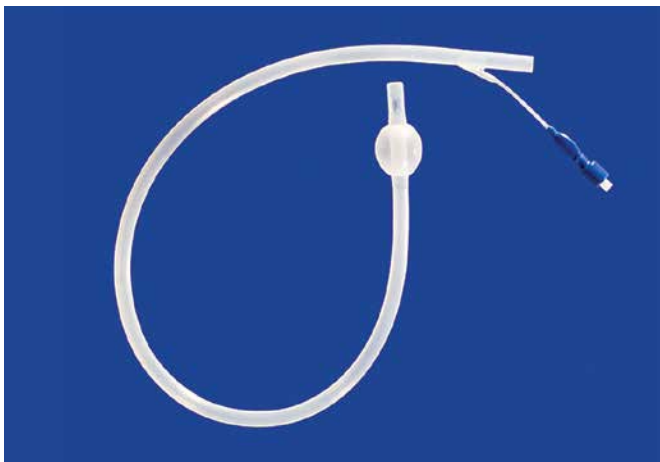

### Uterine Flush Tube

- 28Fr x 190cm flushing tube with spike and multiple exit ports.

DESCRIPTION	ITEM #
28Fr x 190cm (75in)	UFT28190



## Equine Oocyte Collection Set

- For equine transvaginal oocyte collection.
- Laminar flow, no ridges on collection side.
- Aspiration needle is 12Ga x 60cm (24in), stainless steel, double lumen, with an ultra sharp tip to improve visualization under ultrasound.
- Flushing and collection lines are 14Ga x 180cm (72in) PVC attached to a 'Y' adapter.
- #6 silicone bottle stopper with collection port and vent port.

DESCRIPTION	ITEM #
Oocyte Collection Set - Etched Tip Includes 12Ga needle assembly, flushing and collection lines and bottle stopper assembly	OCS
Outer Replacement Needle - Etched Tip 12Ga x 60cm	OCRN
Oocyte Collection Set - Non-Etched Tip Includes 12Ga needle assembly, flushing and collection lines and bottle stopper assembly	OCS-2
Outer Replacement Needle - Non-Etched Tip 12Ga x 60cm	OCRN-2
Replacement Lines Includes Y-port with attached flushing and collection lines	OCRL
Stopper Assembly Includes #6 silicone stopper with collection and vent ports	OCSA

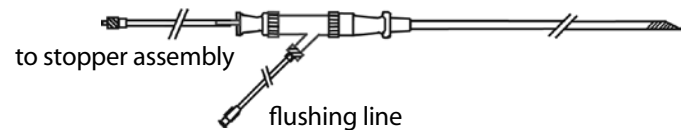

### High Flow Fluid Transfer Set

Ideal for uterine flush. Includes high flow spike, clamp and graduated adapter for 20-40Fr tubes.

DESCRIPTION	ITEM #
Length 30cm (12in)	175490
Length 60cm (24in)	175493



## Tracheal Wash / Aspiration Catheters

### Single Lumen Catheters

Single lumen catheter with female luer lock for medication delivery and sampling at any endoscope accessible site. To maintain sterility during placement, these sets contain a glycol plug.

DESCRIPTION	ITEM #
2.3mm OD x 190cm (76in) for 2.5mm scope	EDC190
2.3mm OD x 220cm (88in) for 2.5mm scope	EDC220
2.3mm OD x 400cm (160in) for 2.5mm scope	EDC400

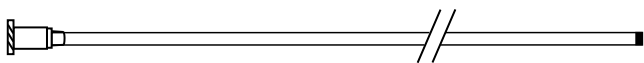

### Double / Triple Lumen Catheters

Two and three lumen sampling catheters enable a sterile specimen retrieval via an endoscope. To maintain sterility during placement, these sets contain a glycol plug in the outer catheter. Once placed, the inner catheter is advanced for retrieval of the sterile specimen.

DESCRIPTION	ITEM #
Two stage catheter - 1.8mm x 190cm (76in) for 2.0mm scope	EMAC700
Two stage catheter - 1.8mm x 250cm (100in) for 2.0mm scope	EMAC700L
Triple stage catheter - 2.3mm x 190cm (76in) for 2.5mm scope	EMAC800

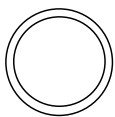

Double Lumen

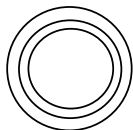

Triple Lumen

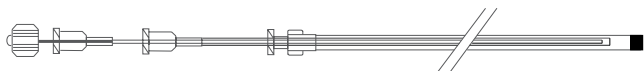

## Indwelling Guttural Pouch Catheter Kit

Placed by viewing the guttural pouch through an endoscope up one nostril and placing the catheter introducer up the other nostril. Non-irritating polyurethane catheter for extended treatment of the guttural pouch. Kit includes polyurethane catheter with coils, bendable introducer and attachable luer lock adapter. The catheter can be left in for days, secured to the halter and protected by a grazing muzzle or cut to desired length.

Catheter dimensions: 12Ga x 135cm (54 Inches).

DESCRIPTION	ITEM #
Catheter Kit	9500
Catheter Only	9510

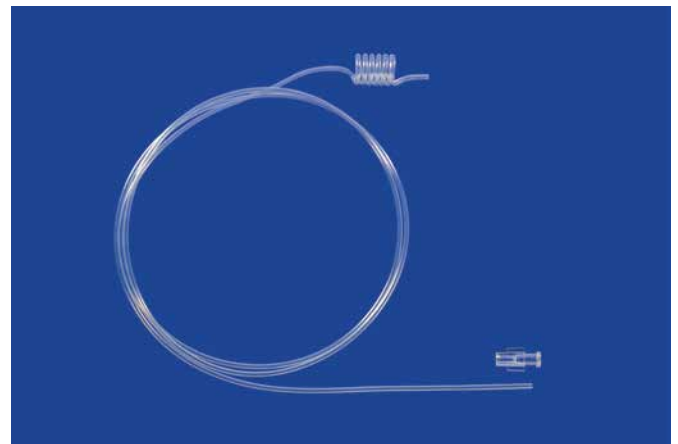
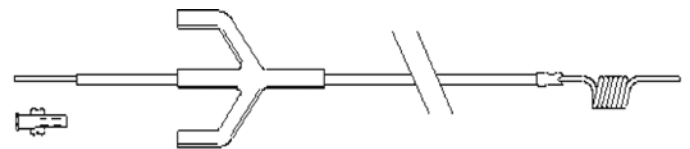

## Lance-A-Lot

Aspiration and injection needle (17Ga) with female luer lock. Ideal for lancing and injecting ethmoid hematomas and uterine cysts.

DESCRIPTION	ITEM #
2.5mm x 190cm (76in)	LAN190

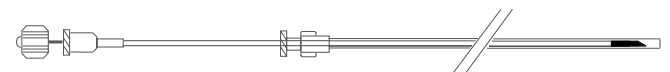

## Laprosopic Large Animal Retrieval Pouch

### LARGE BAG

- Retrieval pouch for a variety of large animal surgical procedures.
  - Ovariectomies with normal ovaries and granulosa cell tumors.
  - Removal of cryptorchid testicle.
  - Removal of bladder stones.
  - Removal of abdominal cavity tumors.
  - Harvesting biopsy specimens.
- **1500ml detachable bag.**
- Sturdier than human product.
- More economical.

ITEM #EP810

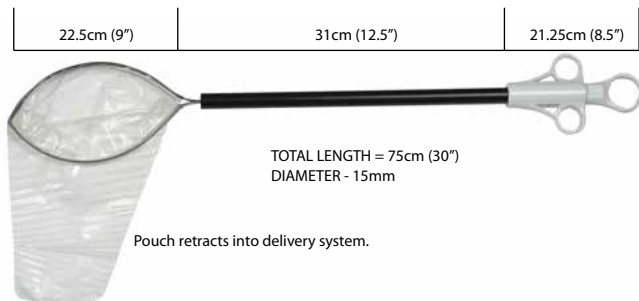

## Cytobrush – Protected

- Indicated to collect tissue samples from the bronchi and/or upper and lower gastrointestinal tracts for the diagnosis of suspected pathology in the airway.
- Tube within a tube design. The outer tube has a water soluble glycol plug in the distal end to protect the inner lumen brush from contamination as it travels through the endoscope channel. When the sample site is reached, the forward motion of the inner tube safely expels the plug, and deploys the brush. After sample collection, the brush is retracted into the outer tube, and removed from the scope channel.
- Fits down 2.0mm endoscopic channel.
- Sheathed catheter with plug for sample protection is 1.8mm x 180 cm.
- 10mm bristled brush with outside diameter of 2mm and radiopaque distal end cap.
- Handle with ring provides easy deployment and retraction of brush.

DESCRIPTION	ITEM #
1.8mm x 180cm (72in)	CYT180

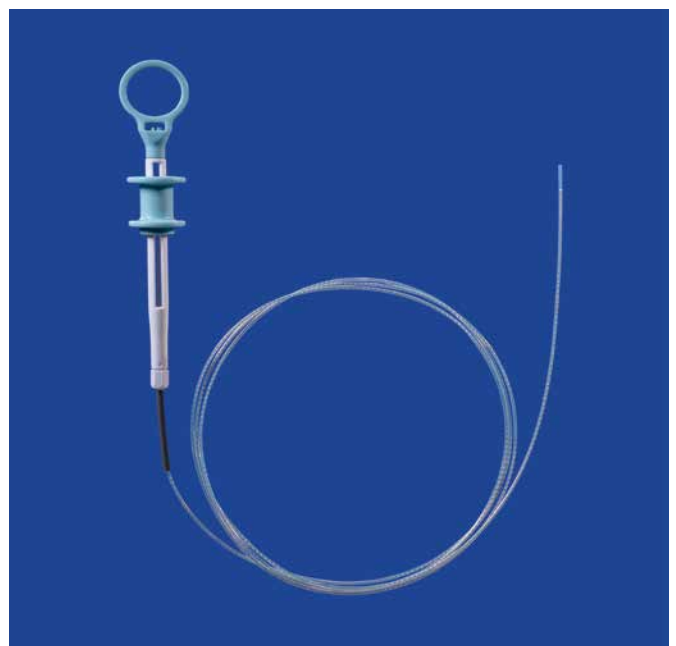

## Fluid Collection and Delivery

### High Flow IV Administration Sets

DESCRIPTION	ITEM #
High flow set includes drip chamber, 72in (180cm) tubing, pinch clamp, needle free injection site, and spin luer lock. 12 drops/ml Priming Volume = 42ml	175497



DESCRIPTION	ITEM #
High flow set includes vented spike with filter, 72in (180cm) tubing, pinch clamp, needle free injection site, and spin luer lock. 12 drops/ml Priming Volume = 32ml	175498



### EquiSet IV Administration Set

DESCRIPTION	ITEM #
<b>Improved - Now available with Y injection site</b> Economical large bore (30Fr x 300cm/120in) non-vented Y-set with 2 spikes, 3 clamps, roller flow adjustment, and spin luer lock adapter. Needle free injection port.	8V0002



### Arthroscopy Fluid Line Wound Flushing Line

DESCRIPTION	ITEM #
High flow infusion set includes spike, 10 feet of tubing, clamp, and spin luer lock. Fits basic peristaltic pump.	175499





## Blood Collection Set

DESCRIPTION	ITEM #
High flow collection set that attaches directly to venous catheter and vacutainer bottle. Set includes 72in (180cm) <b>large bore</b> tubing, injection site, drip chamber, and spin luer lock. Priming volume = 42ml	175484

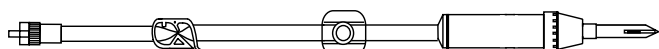

## High Flow Fluid Transfer Set

Ideal for uterine flush. Includes high flow spike, clamp, and graduated adapter for 20-40Fr tubes.

DESCRIPTION	ITEM #
Length 30cm (12in) Priming volume = 8ml	175490
Length 60cm (24in) Priming volume = 20ml	175493



## Controlled Flushing Set

- Set includes vented bag spike, 90cm (36in) tubing and bi-directional valve.
- Use for various flushing needs - BAL, joint, ear, wound, ovum pickup.
- The bi-directional valve allows for repeat aspiration from the bag and controlled flushing without opening the system.
- Eliminates the need to pre-fill syringes.
- Spike the flush medium, attach syringe to female luer of valve, fill syringe, flush, then repeat process.

ITEM #CFS36



## Blood Delivery with Filter

DESCRIPTION	ITEM #
<b>High flow blood</b> administration set for delivery of whole blood, cellular components, and fresh-frozen plasma for transfusions. Set includes 80in (203cm) large bore tubing, 200 micron blood filter, needle free injection site, and 360° spinner. <b>SAVES TIME.</b> Priming volume = 36ml	BF200-2

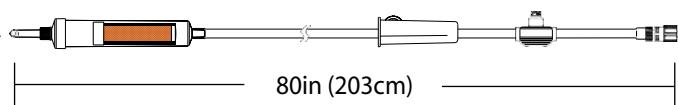

## Fluid Collection and Delivery

### 10 Drop IV Administration Set

DESCRIPTION	ITEM #
Universal spike, 224cm (88in) tubing, roller clamp, slide clamp, one injection site located 11 inches above distal end, spin connector. Priming volume = 25.6ml	175250
Universal spike, 261 cm (103in) tubing, roller clamp, slide clamp, two injection sites located 9 inches and 87 inches above distal end, spin connector. Priming volume = 28ml	175255



### 15 Drop IV Administration Set

DESCRIPTION	ITEM #
Administration set with vented spike, 76 inch tubing (190cm), drip chamber, rotating luer lock, roller clamp and injection site. Replacement for the discontinued BD15 Drop Set. Priming Volume = 13.3ml	175278



### Secondary Venoset

DESCRIPTION	ITEM #
Deliver a small amount of medication quickly. This set allows pressurization when used with squeeze bulb (Item #175590) of a bag or bottle. Replacement for the discontinued Abbott secondary venoset. Priming Volume = 4ml Tubing length is 23in (58cm).	175720

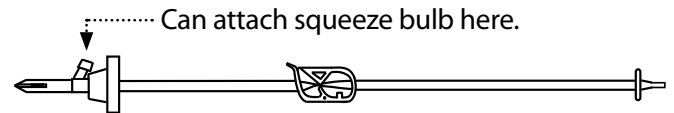

### Fluid Transfer Set

High flow spikes to transfer fluid between bags, 45cm (18in) ITEM # FTS18
--



### Fluid Control Dial

DESCRIPTION	ITEM #
Easily adjust infusion rate from 10ml/hour up to <b>350ml/hour</b> when used with gravity system. When used with pressurized system, flow is four times faster. Tube length is 18in (45cm).	175480



## Foal/Horse Urinary Foley Catheters

### Pressure Infusors

High performance pressure infusor.

- Provides easy view of fluid bag and fluid level.
- Special built-in hook allows fluid bag to be replaced without removing pressure infusor from hanging device.

DESCRIPTION	ITEM #
1000ml cuff with squeeze bulb and 3-way stopcock	175500
3000ml cuff with squeeze bulb	175930
5000ml cuff with squeeze bulb	175950
Inflation Squeeze Bulb Assembly Includes bulb and three-way stopcock	175590



175500



175590



175930 &amp; 175950

- Balloon cuff retains catheter in the bladder.
- The wire provides rigidity to save time and trauma.
- Radiopaque silicone material.
- 8Fr and 10Fr sizes packaged in a kit with catheter, wire stylet, suture wing, suture pack, female luer lock christmas tree, cap, lubricating gel packet, gauze, and syringe.
- 12Fr to 24Fr include wire stylet, female luer lock christmas tree, suture wing, and cap.

DESCRIPTION	ITEM #
8Fr x 30cm (12in) with 3cc balloon	UC812
8Fr x 60cm (24in) with 3cc balloon	UC824
8Fr x 90cm (36in) with 3cc balloon	UC836
10Fr x 30cm (12in) with 5cc balloon	UC1012
10Fr x 45cm (18in) with 5cc balloon	UC1018
10Fr x 90cm (36in) with 5cc balloon	UC1036
12Fr x 30cm (12in) with 10cc balloon	UC1212
12Fr x 55cm (21in) with 10cc balloon	UC1221
14Fr x 23cm (9in) with 10cc balloon	UC1409
14Fr x 55cm (21in) with 10cc balloon	UC1421
16Fr x 55cm (21in) with 10cc balloon	UC1621
18Fr x 55cm (21in) with 10cc balloon	UC1821
20Fr x 55cm (21in) with 10cc balloon	UC2021
22Fr x 55cm (21in) with 10cc balloon	UC2221
24Fr x 42cm (16in) with 30cc balloon	UC2416
24Fr x 150cm (59in) with 30cc balloon	UC2459

Customizable Foal Urine Collection products on page 23.



## Large Animal Trans-Tracheal Wash Kit/TTL

Catheter-over-needle insertion method through the skin into the trachea. The semi-rigid flushing catheter has a stylet and luer adapter. The flushing catheter is packaged in a protective sleeve to allow handling without a glove.

DESCRIPTION	ITEM #
10Ga x 2.25in steel introduction catheter with 12Ga x 70cm (28in) flushing catheter for horses and foals	TW1228
14Ga introducer with 16Ga x 70cm (28 in) flushing catheter for large dogs and neonatal foals	TW1628

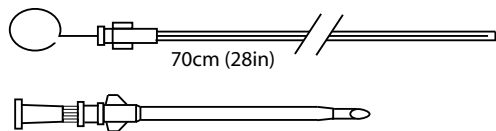

INTRODUCERS are 10Ga or 14Ga.

## Equine Joint Infusion Kit

Provide continuous localized infusion of antibiotics directly into the affected joint. A crush resistant 5Fr (16Ga) catheter is inserted using a 6Fr (14Ga) peel away introducer. The lightweight administration pump will hold up to 100ml. Two flow control tubes included, 0.8ml/hr and 2.5ml/hr.

ITEM #9100



See MILA website for detailed insertion instructions written by Stephen B. Adams DVM, MS and Timothy B. Lescun, BVSc.

## Small Animal Tracheal Wash

Catheter-over-needle insertion method. The semi-rigid flushing catheter has a stiffening stylet and luer adapter. The flushing catheter is packaged in a protective sleeve to allow handling without a glove.

DESCRIPTION	ITEM #
<b>Medium Sized Dog</b> - 16Ga x 41cm (16in) flushing catheter with 14Ga introducer	TW1616
<b>Large Dog</b> - 16Ga x 70cm (28in) flushing catheter with 14Ga introducer	TW1628

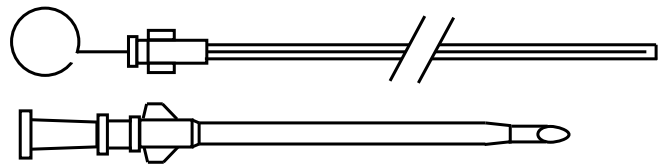

## Large Animal Broncho-Alveolar Lavage Catheter (BAL)

- Open end silicone heavy wall radiopaque catheter for the lavage of selected segments of the lung fields using the nasotracheal approach.
- Distal balloon can be inflated to prevent retrograde fluid flow around the tube. Fill according to clinic protocol.
- Proximal two-way fitting allows simultaneous connection for both irrigation and aspiration.
- Reuseable.

DESCRIPTION	ITEM #
10mmOD, 2.5mmID, 240cm (96in)	BAL240
10mmOD, 2.5mmID, 300cm (120in)	BAL300
Replacement Stopcock (10 pack)	2400
Controlled Flushing Set - for continual irrigation - see page 65	CFS36



## Equine Guarded Pharyngeal Swab Kit

- For collection of a **sterile** sample.
- An inert capsule protects the inner tube while advancing through the nostril.
- Tube within a tube style.
- Outer tube has a smooth, atraumatic distal end.
- After advancing, the capsule is pushed out by the inner tube and dissolves.
- Swab area for sample, and then retract inner tube into the outer tube before withdrawing all from the nostril.
- Kit includes swab, gloves, and scissors.
- Length = 62.5cm (25in) OD = 23Fr

ITEM #5240

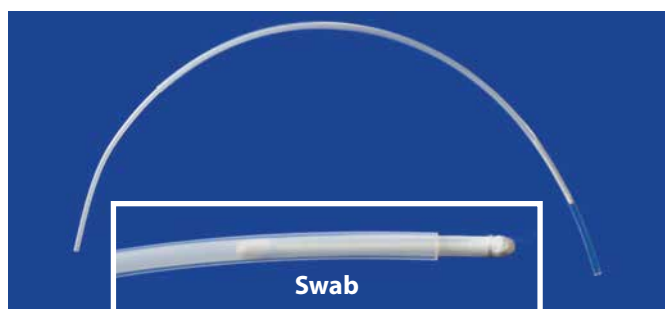

## Flushing Wye Set for Large Chest Tubes

Flush large chest tubes with this large bore (6.35mm ID) wye set.

ITEM #CTF6

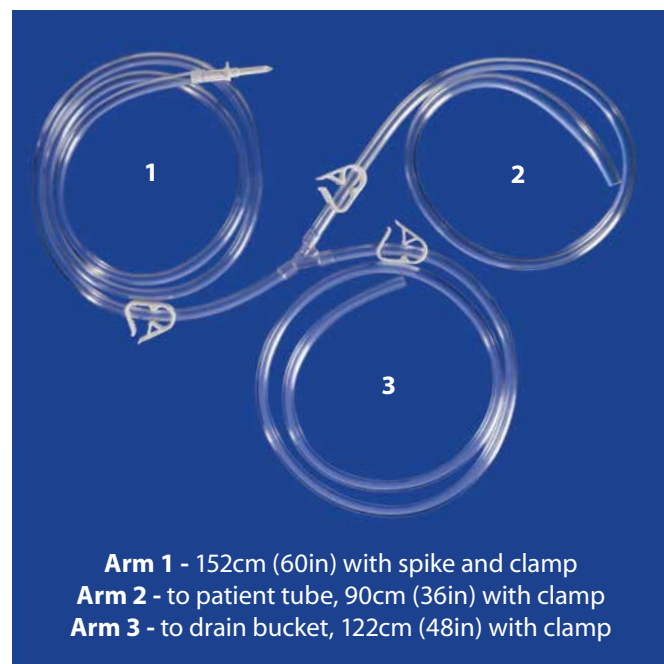

## Equine Castration Drape

Drape size 150cm (60in) x 90cm (36in) clear film with 20cm (8in) x 15cm (6in) adhesive fenestration and **edge strips**.

- **Edge strips** make this drape ideal for field use, and many types of procedures.
- **Adhesive** aperture.
- Sterile, impervious translucent film.
- Provides superb translucent protection with optimal drapeability.
- Helps maintain patient temperature.

ITEM #ECD

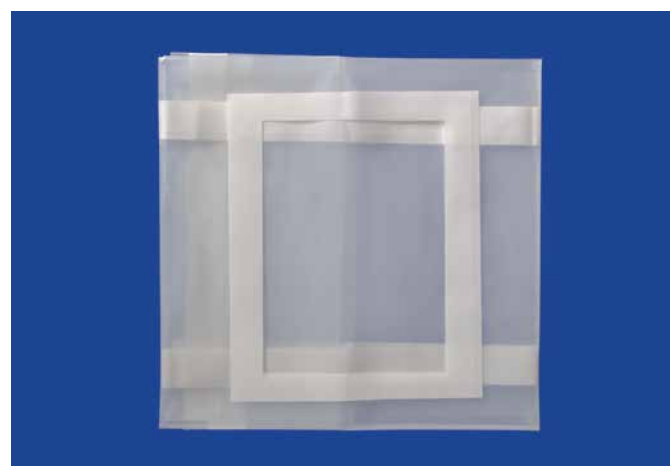

## Accessories and Components

### Christmas Tree Style Connectors

DESCRIPTION	ITEM #
Large Dual End 4-12mm Each individually packed and sterile	2300 <b>(10 pack)</b>
Small end 4.0-6.0mm Large end 7.5-11.5mm Each individually packed and sterile	2320 <b>(10 pack)</b>
Female luer lock adapter accepts 20-40Fr tube Each individually packed and sterile	2350 <b>(10 pack)</b>
Female luer lock adapter accepts 11-22Fr tube Each individually packed and sterile	2360 <b>(10 pack)</b>
Male luer lock oxygen connector for 11-22Fr tube Each individually packed and sterile	2370 <b>(10 pack)</b>
Male luer lock adapter accepts 20-40Fr tube Each individually packed and sterile	2380 <b>(10 pack)</b>

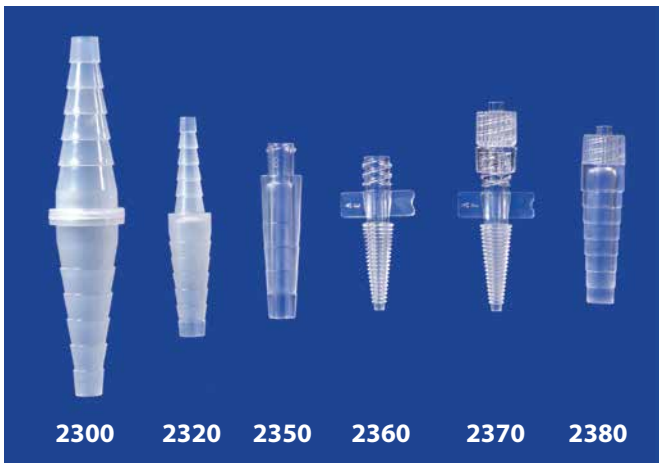

### .2 Micron Bacteria Filter

- Surface area: 5 square centimeters.
- Volume limit depends on bacteria burden of liquid being filtered.

DESCRIPTION	ITEM #
With male and female luer locks. Each individually packed and sterile	2420 <b>(10 pack)</b>



### Connectors

DESCRIPTION	ITEM #
Female to Female Luer Connection Each individually packed and sterile	2440 <b>(10 pack)</b>
Male to Male Luer Connection Each individually packed and sterile	2445 <b>(10 pack)</b>
Three female connectors with a male rotating luer lock. Each individually packed and sterile	2460 <b>(10 pack)</b>



### Caps

- **Tethered Cap** (8090) attaches to the catheter or extension hub to cover the injection port. Not for needle free valves.
- **Stemless Luer Lock Cap** (8099) 10 pack, non-sterile. Universal, works with all injection ports.

DESCRIPTION	ITEM #
Tethered Cap	8090
Stemless Luer Lock Cap (10 pack)	8099



## Conversion Chart

FRENCH	GAUGE	INCH	MM
1	29	0.013	.33
2	23	0.025	.64
3	20	0.039	1
4	18	0.053	1.35
5	16	0.066	1.67
6	14	0.079	2
7	13	0.092	2.3
8	12	0.105	2.7
9	—	0.118	3
10	10	0.131	3.3
11	—	0.144	3.7
12	—	0.158	4
13	—	0.170	4.3
14	—	0.184	4.7
15	—	0.197	5
16	—	0.210	5.3
17	—	0.223	5.7
18	—	0.236	6
19	—	0.249	6.3
20	—	0.263	6.7
22	—	0.288	7.3
24	—	0.315	8
26	—	0.341	8.7
28	—	0.367	9.3
30	—	0.393	10
32	—	0.419	10.7
34	—	0.445	11.3

Length: 1 inch = 2.54 centimeters

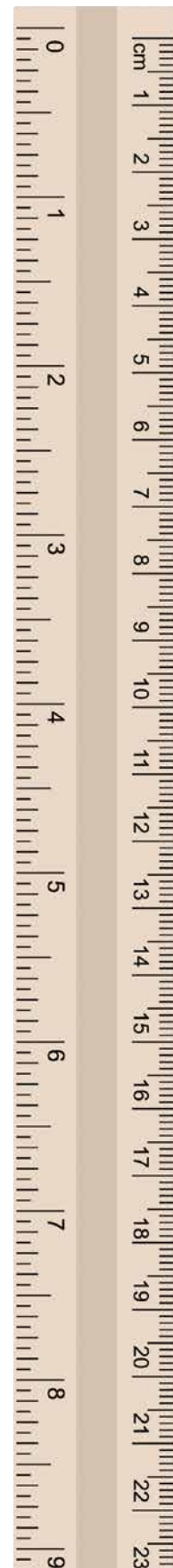

### Stopcocks

DESCRIPTION	ITEM #
Three-way with luer slip	2400
Each individually packed and sterile	<b>(10 pack)</b>
Three-way with luer lock	2405
Each individually packed and sterile	<b>(10 pack)</b>
Three-way with 8in extension	2408
Three-way with High Flow Needle Free Valves	2412

For **Automatic 3-Way**, see page 42.

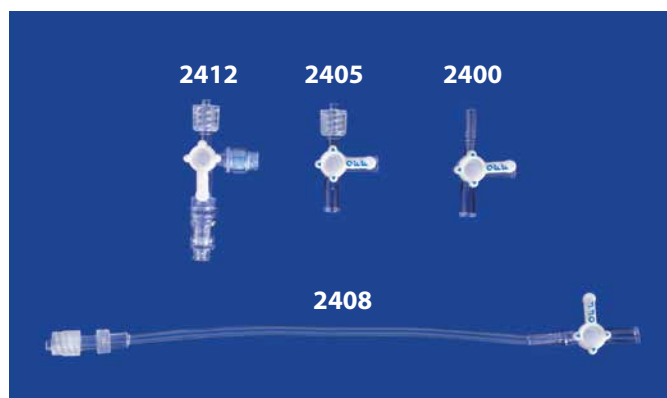

### Suture Wings

Suture wings are sold in **packs of 10**, non-sterile.

DESCRIPTION	ITEM #
20Ga with blue clamp	2530
18Ga with blue clamp	2540
16Ga with blue clamp	2550
14Ga with blue clamp	2560
7Fr with blue clamp	2570
8Fr with blue clamp	2572
9Fr with blue clamp	2575
14Fr translucent	2580
18Fr translucent	2590



ITEM #	PAGE												
1006	14	4206	9	175720	66	E1830	34	JP4	48	PEG20	30	SP15	49
12-004	56-57	5240	69	175800	41	E1806	47/59	JP7	48	PGS16	30	SP19	49
12-006	56-57	5380	53	175930	67	E1808	47/59	JP10	48	PGS20	30	T1803	58
12-007	56-57	6612	60	175950	67	E2008	47/59	JP13	48	PIN1	13	T1806	58
12-008	56-57	6613	60	AR2206	12	E2103	47/59	LA1611-A	7	PIN2	13	T2025	58
12-055	56-57	6615	60	BAL240	68	E2104	47/59	LA1615	7	PIN3	13	T2215	58
12-100	57	7100	60	BAL300	68	ECD	51/69	LA1615-A	7	PIN13	13	T2225	58
1211	14	8080	20	BE1012	37	E-Y	34	LA1615-PI	8	PIN20	13	TTC35-100	54
1212	14	8090	20/70	BE1420	37	EDC190	62	LA1620	7	PIN28	13	TTCIC50-80	54
1212F	15/45	8095	20	BE1830	37	EDC220	62	LA1620-A	7	PP316-1816	28	TTNC25-55	54
1402	14	8098	20	BE14PAI	37	EDC400	62	LA1620-PI	8	PP822-1222	28	TW1228	68
1403	14	8099	9/20/70	BE-ACC	37	EMAC700	62	LA1415	7	PP842-1042	28	TW1616	68
1404	14	8200	9/20	BE-BIG60	37	EMAC700L	62	LA1420	7	PPD	9/51	TW1628	68
1404F	15/45	8509	19	BF15	12	EMAC800	62	LA1420-2P	7	PPDK8Fr	44	UC306	22
1411	14	8515	19	BF18	12	EP810	63	LA1420-PI	8	PPDK12Fr	44	UC306S	22
1412	14	8518	17	BF200-2	65	ETA20-90	52	LA1220	7	PT625	26	UC310	22
1412F	15/45	8530M	17/23	BL8	48	ETC1055	52	LA7FD20	7	PT825	26	UC310S	22
1510	58	8540	19	BL11	48	ETC1155	52	LA7FT15	7	RPEG16	30	UC506	22
1603	14	8541	19	BMAN8	21	ETC20	52	LAN190	62	RPEG20	30	UC506S	22
1604	14	8544	19	BMAN11	21	ETC25R-100R	52	LL1990	10	SA2410	6	UC510	22
1604F	15/45	8545	19	BMAN15	21	ETE0880	53	LL2045	10	SA2012	6	UC510S	22
1611	14	8550M	17	BN1408	21	ETE1080	53	LL2425	10	SA1915	6	UC512	24
1612	14	8570	19	BN1415	21	ETE1580	53	LLD1925	10	SA1915-PI	8	UC521	24
1802F	15/45	8570M	19	BN1608	21	ETN10	52	LLD2020	10	SA1925	6	UC600	23
1804	14	8572	17	BN1615	21	ETN15	52	LLD2220	10	SA1925-PI	8	UC600K	23
1804F	15/45	8572M	17	BT03	40	ETUN14	35	M5555	31	SA1815	6	UC612	24
1806	58	8573M	19	BT20	40	ETUN18	35	MC40	19	SA1825	6	UC624	24
1808	58	8575	17	CatModel	36	EZPD-3	11	MC43	19	SA1609	6	UC636	24
1810	58	8585	19	CCS-XS-XL	35	EZ1515	11	MC44	19	SA1615	6	UC812	24/25/67
1811	14	8590	17	CCP-XS-XL	35	EZ1525	11	Mic-Key	31	SA1615-2P-PI	8	UC824	24/25/67
1903	58	8590M	17/23	CC-Pads	35	EZ1545	11	NB-STIM	46	SA1620	6	UC836	24/25/67
2008	58	8V0002	64	CFS36	65/68	EZTN15	11	NBMP	46	SA1625-2P-PI	8	UC1000	23
2011	14	9100	68	CG100	39	EZTN25	11	NBCA	46	SA1630	6	UC1000K	23
2206	58	9203	55	CG150	39	EZC-5	11	NBCC	46	SA1406	6	UC1018	24/25/67
2217	14	9206	55	CG200	39	FCT12	60	NB2205	47/58	SA1420	6	UC1036	24/25/67
2300	29/70	9243	55	CG400	39	FCT4	60	NB2108	47/58	SA4FD08	6	UC1212	24/25/67
2320	29/70	9500	62	CT1210	38	FM2000-2400	44	NG3105	33	SA4FD08-PI	8	UC1212C	24
2350	39/70	9510	62	CT1215	40	FMRB	44	NG622-1243	33	SA4FD13	6	UC1221	24/25/67
2360	70	175042	45	CT12Fr16	38	FTE60	32	NG622W	33	SA4FD13-PI	8	UC1221C	24
2370	29/70	175044	45	CT1404	38	FTS18	66	NG843W-3	33	SA4FD30	6	UC1221C	24
2380	29/70	175052	45	CT1410	38	G050	50	NG843W-7	33	SA5FD08	6	UC1221C	24
2400	68/71	175056	45	CT1415	40	G100	48/50	NG1043W	33	SA5FD08-PI	8	UC1409	24/25/67
2405	71	175250	56/57/66	CT2015	40	G150	48/50	NG1450	33	SA5FD13	6	UC1621	24/25/67
2408	71	175255	56/57/66	CT2022	40	G200	48/50	NG18100	33	SA5FD25	6	UC1621C	24
2412	71	175278	66	CT3022	40	G400	48/50	NGP522S-1036S	32	SA5FD25-PI	8	UC1821	24/25/67
2420	55/60/70	175300	41	CTF6	43/69	GDV1-4	27	NGP622-1243	32	SA7FD15	6	UC1821C	24
2440	70	175380	41	CTT10S-14S	40	GDV3L	27	NGP622W-843W	32	SA7FD20	6	UC2000K	23
2445	70	175420	41	CTT16-32	40	GW1845	9	NGP1243W	32	SA5FT08	6	UC2021	24/25/67
2460	70	175425	41	CVP35	11	GW1850N	9	OCLR	61	SA5FT13	6	UC2021C	24
2530-2575	71	175440	42	CYGA24	26/31	GW2170N	9	OCRN	61	SA5FT30	6	UC2212	24/25/67
2580	34/71	175440NB	42	CYT180	63	GW3580N	9	OCS	61	SA7FT15	6	UC2416	24/25/67
2590	34/71	175450	42	DBT16	49	H2900	43	OCS-2	61	SA7FT30	6	UC2416C	24
2675	14	175450NB	42	DBT20	49	H5300	43	OCSA	61	SA7FT60	6	UC2459	24/25/67
3240	11	175460	42	DBT32	49	HDL716	13	OSD	51	SA8FQ20	6	UC2459C	24
3360	11	175480	66	DIFF2	55	HDL816	13	OT2113	27/59	SAC4	27	UC412	24
3460	11	175484	65	DIFF4	55	HDL1216	13	OT2125	27/59	SAC6	27	UCG610	25
3560	11	175490	61/65	DIFF6	55	HDL1225	13	OT2140	27/59	SE1215	36	UCG810	25
3565	11	175493	61/65	DIFF7	55	IC50-80	54	OT2320	59/60	SE1415	36	UCT	23
4203	9	175497	64	DIFF9	55	IC1801-2475	15	OT2330	59/60	SE2015	36	UFC3680	61
4204	9	175498	64	E1030	34	ISK4-9	12	OTC2330	59/60	SE2022	36	UFT28190	61
4205	9	175499	64	E1413	34	J1036	31	OT3025	59/60	SE3022	36	V2030	12
4205.5	9	175500	67	E1430	34	J636	31	PBC20	26/36	SP07	49		
		175590	67	E1450	34	J836	31	PEG16	30	SP10	49		



MILA International is an innovative company which has developed veterinary medical products otherwise commercially unavailable. We appreciate the opportunity to serve the world’s diverse veterinary community since 1991.

**QUESTIONS/CONCERNS:**

---

---

---

---

---

---

---

---

---

---

---

---

---

---

---

---

---

---

---

---

---

---

---

---

---

### Custom Program

Have a custom need? Separately packaged sterile components? A custom kit for your hospital? Contact MILA with details. There are reasonable minimum requirements.

### Ordering Information

- 1. **Website:** www.milaint.com  
**Phone:** + 1-859-957-1722  
**Toll Free:** 888-645-2468
- 2. Order **directly** from MILA on-line at our website, or by phone. Orders placed directly with MILA by 2pm EST will ship the same day.  
OR
- 3. Order through an Authorized Distributor listed on pages 78-79.
- 4. Credit cards accepted.

**Mis-shipment / Damaged Items**  
Notification must be given within 10 days of receipt of purchase for credit to be issued.

### Returns

- 1. Notification must be given before return.
- 2. Full credit will be allowed for the following conditions:
  - A. Merchandise shipped in error against purchase order.
  - B. Defective merchandise.
- 3. When unopened merchandise is authorized to be returned for any reason other than above, credit will be:
  - 80% - less than one year old
  - 50% - one to two years old
  - No credit - more than two years old

Prices Subject to Change Without Notice.

**UNITED STATES (USA)****Animal Health International**

Greeley, CO  
800-203-5620

**Betances - Puerto Rico**

Caguaus, Puerto Rico  
787-745-2390

**Covetrus North America**

Dublin, OH  
800-551-3861

**Midwest Veterinary Supply**

Burnsville, MN  
800-643-9378

**MWI Animal Health**

Nampa, ID  
800-824-3703

**Patterson Veterinary Supply**

Sterling, MA  
800-225-7911

**Penn Veterinary Supply, Inc.**

Lancaster, PA  
800-233-0210

**POSS Medical**

Tallahassee, FL  
850-661-4197

**Victor Medical**

Irvine, CA  
800-854-6152

**INTERNATIONAL****AUSTRALIA**

CPP Cardio Pulmonary Products  
Sydney  
Email: cpp112@bigpond.net.au  
Phone: 61 407 277 295

Vetquip  
Sydney  
Email: sales@vetquip.com.au  
Phone: 61 2 9889 6666

VetTech Australia  
Sydney  
Email: customerservice@vtaus.com.au  
Phone: 61 2 9131 2326

**BELGIUM**

Medini  
Oostkamp  
Email: instruments@medini.be  
Phone: 32 50 311876

**BRAZIL**

Digicare Animal Health  
Rio de Janeiro  
Email: vendas@digicarebiomedical.com  
Phone: 21 3373 1378

**CANADA**

Central Sales Limited  
Brampton, ON  
Website: www.centralsales.ca  
Phone: 800-387-2522

**CENTRAL/SOUTH AMERICA**

All Veterinary Supply, Inc.  
Florida  
Email: sales@allveterinarysupply.com  
Phone: 305-599-6125

**CHILE**

Improvetch Chile Ltda  
Santiago  
Email: improvetch@gmail.com  
Phone: 569 92241390

**COLOMBIA**

Vet Supplies Colombia  
Bogota  
Email: vetsuppliescol@gmail.com  
Phone: 57 313 4902283

**COSTA RICA**

Innovett  
Pozos de Santa Ana  
Email: ventas@innovett.com  
Phone: 506 2203 5854

VES (Veterinaria Especializada)  
Heredia  
Email: info@vescr.com  
Phone: 506 6005 6540

**DENMARK**

E-Vet  
Haderslev  
Email: sales@evet.dk  
Phone: 45 7453 0848

Jorgen Kruuse A/S  
Langeskov  
Email: info@kruuse.com  
Phone: 45 72 14 1511

**ECUADOR**

Veterinary Equipment and Services  
Quito  
Website: www.ves.com.ec  
Phone: 593 2 246 876

**FINLAND**

OneMed Oy  
Helsinki  
Email: asiakaspalvelu@onemed.com  
Phone: 358 20 786 6810

Vetman  
Halikko  
Email: vetman@vetman.fi  
Phone: 358 2 7221 222

**FRANCE**

AdVetis Medical  
Montreuil  
Website: AdVetis-Medical.com  
Phone: 3301 5586 1040

Alcyon  
Paris  
Email: contact@alcyon.com  
Phone: 3301 53903939

Coveto  
Montaigu  
Email: materiel@coveto.fr  
Phone: 33 02 51488088

Genia  
St. Hilaire de Chaleons  
Email: V.Baillet@genia.fr  
Phone: 33 02 40 03 3537

**GERMANY**

BioRanch  
Telgte  
Email: [andre.schaefer@bioranch.de](mailto:andre.schaefer@bioranch.de)  
Phone: 49 2504 70 99 250

Conovet  
Achern  
Email: [info@conovet.de](mailto:info@conovet.de)  
Phone: 49 7841 6840 887

**HUNGARY**

Hungarovet Allatkorhaz Kft.  
Budapest  
Website: [www.hungarovetproducts.com](http://www.hungarovetproducts.com)  
Phone: 36 1 362 2699

**IRELAND**

Duggan Veterinary Supplies Ltd  
Co. Tipperary  
Email: [sales@dugganvet.ie](mailto:sales@dugganvet.ie)  
Phone: 353 504 43169

**ITALY**

Alcyon Italia Spa  
Marene - CN  
Email: [marketing@alcyonitalia.com](mailto:marketing@alcyonitalia.com)  
Phone: 800 062865

**KOREA**

Shin Sung Medi-Tech Co  
Seoul  
Email: [shinsungmt@gmail.com](mailto:shinsungmt@gmail.com)  
Phone: 82 02 323 5256

**MEXICO**

Difarvet SA DE CV  
Jalisco  
Website: [www.difarvet.com](http://www.difarvet.com)  
Phone: 52 33 3836 0070

**NEW ZEALAND**

Kahuvet  
Auckland  
Email: [info@kahuvet.co.nz](mailto:info@kahuvet.co.nz)  
Phone: 64 0800 524883

Shoof International Ltd.  
Cambridge  
Website: [www.shoof.co.nz](http://www.shoof.co.nz)  
Phone: 64 7 827 3902

SVS Veterinary Supplies Ltd.  
Hamilton  
Email: [info@svs.co.nz](mailto:info@svs.co.nz)  
Phone: 64 0800 808 387

**NORWAY**

Jan F. Andersen A/s  
Jevnaker  
Email: [post@jfa.no](mailto:post@jfa.no)  
Phone: 47 61 31 4949

**PORTUGAL**

MSO - Medical Solutions  
Aveiro  
Email: [Artur.Alves@mso.pt](mailto:Artur.Alves@mso.pt)  
Phone: 351 965 079 682

**QATAR**

Al-Dousari Veterinary Services  
Doha  
Email: [aldousarivet@yahoo.com](mailto:aldousarivet@yahoo.com)  
Phone: 974 4481 2281

**ROMANIA**

Blue Vets for Pets  
Bucharest  
Email: [Monica.ifteme@bluevets.ro](mailto:Monica.ifteme@bluevets.ro)  
Phone: 40 722 607 330

**SINGAPORE**

MD Vet Pte Ltd  
Toh Guan Centre  
Email: [mdveterinary@gmail.com](mailto:mdveterinary@gmail.com)  
Phone: 65 622 42688

Novovet  
Sunbird Road  
Website: [www.novovet.org](http://www.novovet.org)  
Phone: 65 90 1234 85

**SPAIN**

LaBouvet  
Torrejon de Ardoz  
Email: [labouvet@labouvet.com](mailto:labouvet@labouvet.com)  
Phone: 34 91 656 17 48

**SWEDEN**

Next2Vet  
Ystad  
Email: [Johnny@next2vet.se](mailto:Johnny@next2vet.se)  
Phone: 46 411 55 57 30

Scandivet  
Enkoping  
Email: [info@scandivet.se](mailto:info@scandivet.se)  
Phone: 46 171 857 70

Swevet AB  
Sjoberg  
Website: [www.swevet.se](http://www.swevet.se)  
Phone: 46 771 21 55 00

**SWITZERLAND**

Covetrus  
Lyssach  
Email: [info@covetrus.com](mailto:info@covetrus.com)  
Phone: 41 34 448 1111

**TAIWAN**

Process Bio Tech  
Taipei City  
Email: [H2OMedicalTech@gmail.com](mailto:H2OMedicalTech@gmail.com)  
Phone: 886 2 23919 598

**THAILAND**

T.J. Animal Health Co., Ltd  
Samut Prakan  
Website: [www.TJAnimal.com](http://www.TJAnimal.com)  
Phone: 66 2 182 9299

**THE NETHERLANDS**

Grovet  
Utrecht  
Email: [info@grovet.com](mailto:info@grovet.com)  
Phone: 30 2479100

**UNITED ARAB EMIRATES**

Al Basha Vet Med  
Dubai  
Email: [albasha@albashavets.com](mailto:albasha@albashavets.com)  
Phone: 971 04 393 5503

German Standard Group  
Website: [www.gsgroup.co/](http://www.gsgroup.co/)  
Email: [info@gsgroup.co](mailto:info@gsgroup.co)  
Phone: 971 04 266 8871

**UNITED KINGDOM**

DMS Plus Limited  
Hampshire  
Email: [sales@dmsveterinary.com](mailto:sales@dmsveterinary.com)  
Phone: 44 1420 520 869



SINCE 1991  
**MILA**  
INTERNATIONAL, INC.  
*Medical Instrumentation for Animals*



Your MILA Distributor:

Order direct

MILA International, Inc.  
7984 Tanners Gate Lane  
Florence, KY 41042 USA

Phone +1-859-957-1722  
Toll free 888-MILAINT (645-2468)  
Web [www.milaint.com](http://www.milaint.com)

